

Before beginning any installation, review Danfoss Operating Instructions for VLT® AQUA Drive FC 202 0.25–90 kW (130R0336) for complete instructions and warnings. This guide neither supplements nor replaces the Owner’s Manual.

Welcome to your new Pentek Intellidrive XL. Please review the following information to setup your drive for constant pressure applications.

For further information please reference the Danfos Design Guide for VLT AQUA Drive FC 202 (130R0337) and the Danfoss Programming Guide for VLT AQUA Drive FC 202 (130R0338).

Safety

⚠ WARNING Hazardous voltage. Can shock, burn, or cause death. Ground pump before connecting to power supply. Disconnect power before working on system components.

- ⚠** Wire pump motor for correct voltage. See motor nameplate.
- ⚠** Ground motor to drive before connecting to power supply.
- ⚠** Meet National Electrical Code, Canadian Electrical Code, and local codes for all wiring.

California Proposition 65 Warning

⚠ WARNING This product and related accessories contain chemicals known to the State of California to cause cancer, birth defects or other reproductive harm.

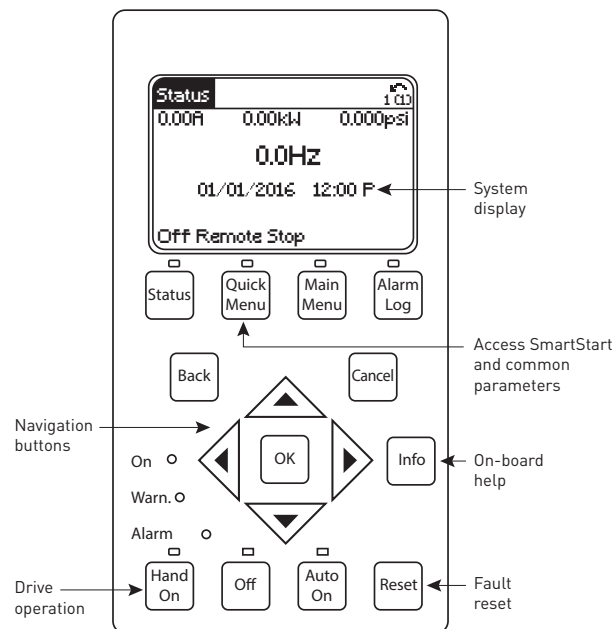

Figure 1. Local Control Panel — Your interface to the drive.

Basic Wiring for Constant Pressure using a 4-20mA Pressure Transducer

Refer to the Danfoss Operating Instructions for complete information on wiring the drive. The steps listed below are required for constant pressure operation with a 4-20mA pressure transducer.

Set the DIP Switch

Step 1: Remove Keypad and Keypad Holder

The keypad holder is secured to the drive with four tabs. Gently squeeze the keypad holder at the top and bottom near where the holder is attached to the drive. See Figure 2.

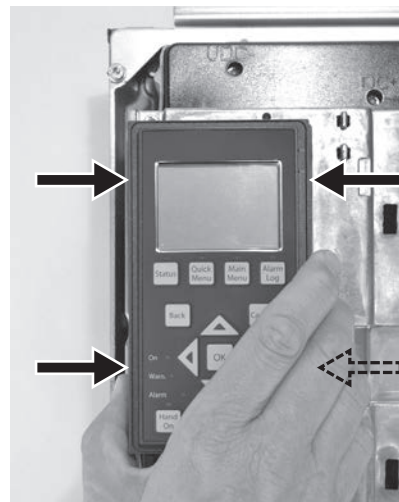

Figure 2.

Once the holder has been loosened, pull the keypad and keypad holder off of the drive. See Figure 3.

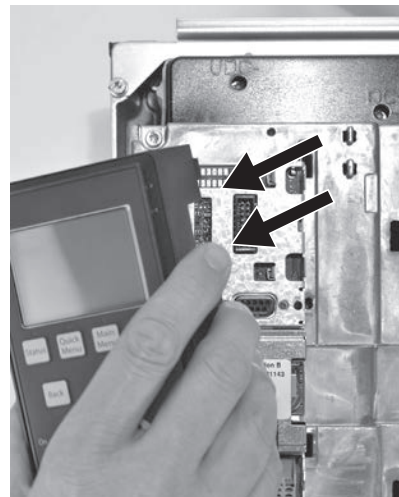

Figure 3.

Step 2: Remove the MCB 109 Option Card

Grasp the card and pull straight out from the drive. See Figure 4.



Figure 4.

Step 3: Install terminal block.

Retrieve the terminal blocks from the Accessory Bag and install as shown. See Figure 5.

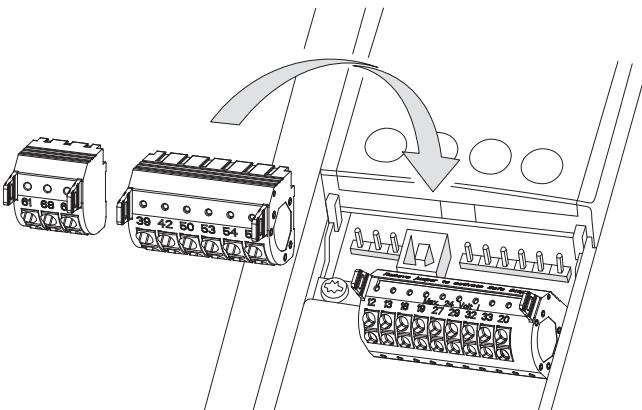

Figure 5.

Step 4: Set A54 dip switch

Using a small screwdriver, move the switch to the right. See Figure 6.

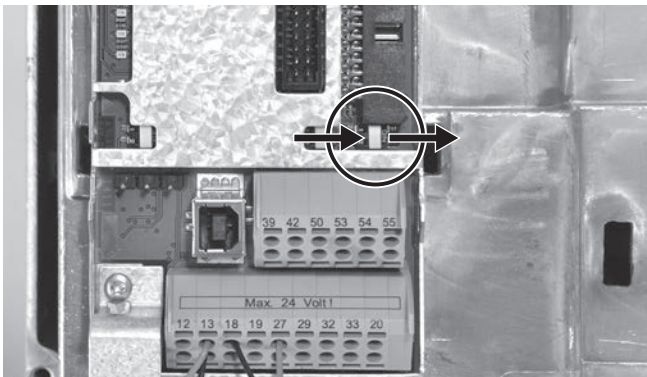

Figure 6.

Step 5: Reassemble the components

Put the components back on the drive. To avoid damaging the option card and keypad, please use care during the reassembly process.

Prepare Transducer Cable

Remove insulation to expose cable shielding. See Figure 7. Cut off green wire (if applicable).

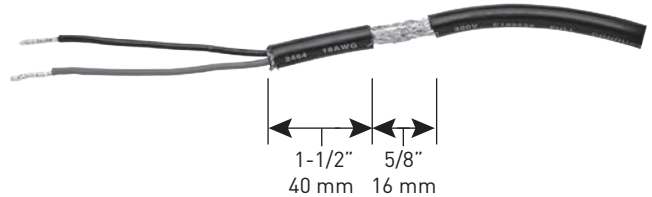

Figure 7.

Wire the Pressure Transducer

The Black wire goes to Terminal 54. The Red wire goes to Terminal 12. Clamp the bare spot on the cable to ground the shielding. See Figure 8.

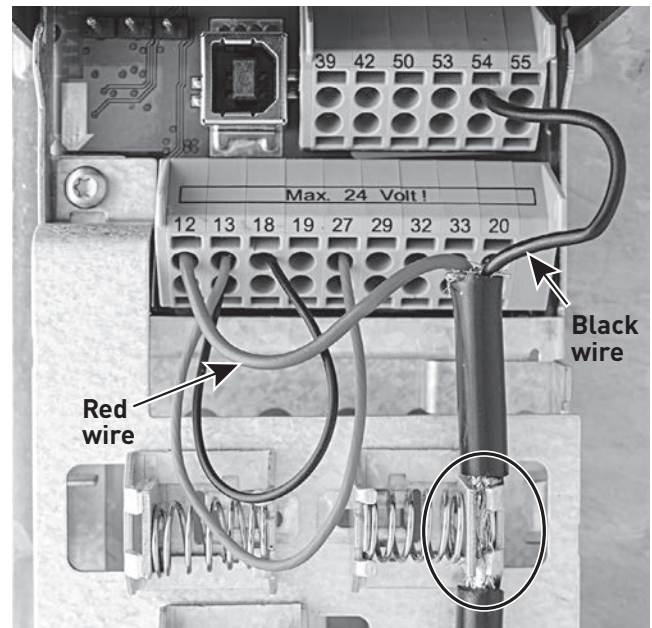

Figure 8.

Install Jumper Wires

Install an 18 - 22 AWG Jumper wire between Terminal 13 and Terminal 27. Install a second Jumper wire between Terminal 13 and Terminal 18. See Figure 8.

ATTENTION: Before programming, the system must be able to be primed and then run with a closed valve to teach the drive about no flow operation.

1

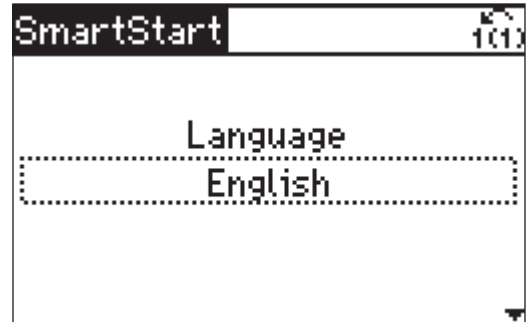
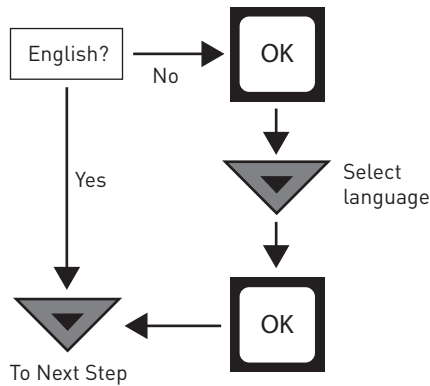

2

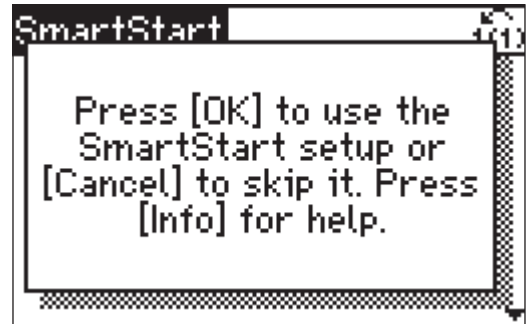

3

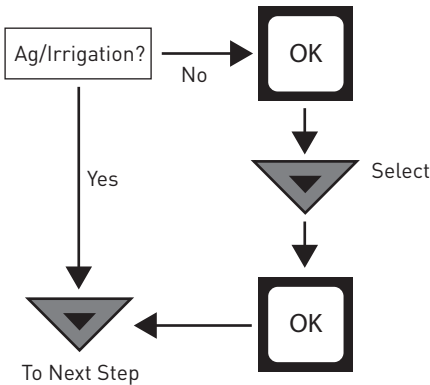

Allow 3 to 5 seconds for the drive to configure. Please wait until the screen shows Step 5 before proceeding.

4

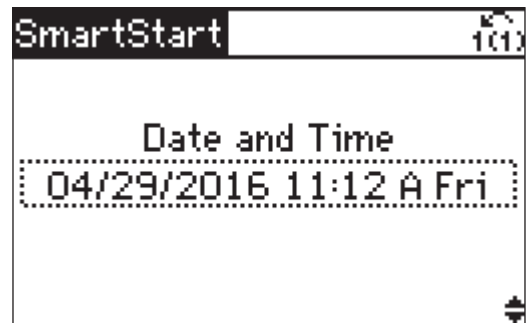
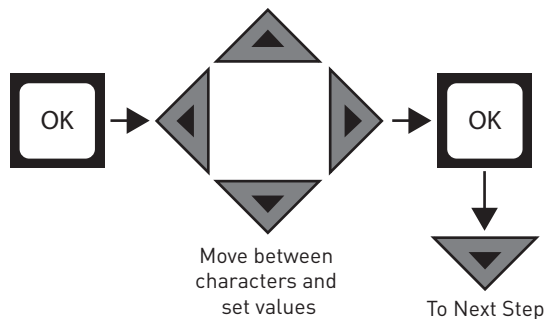

5

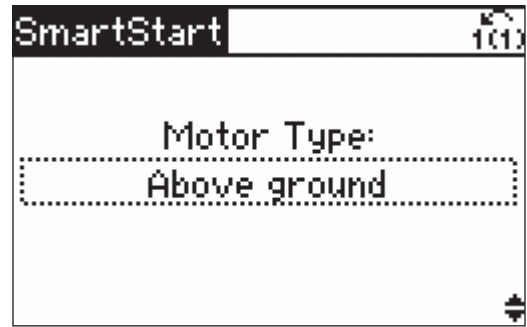
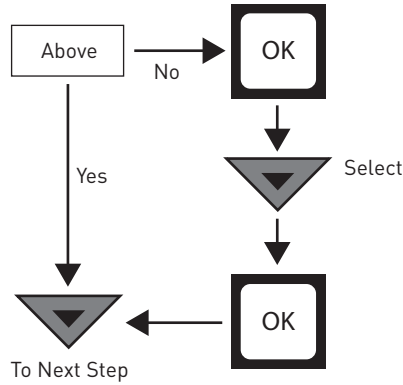

6

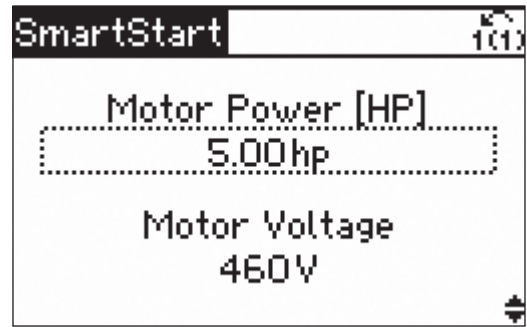
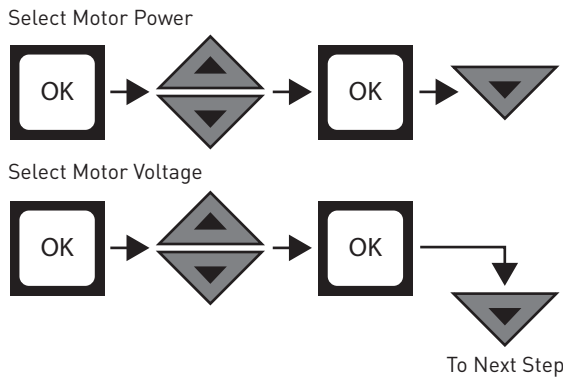

7

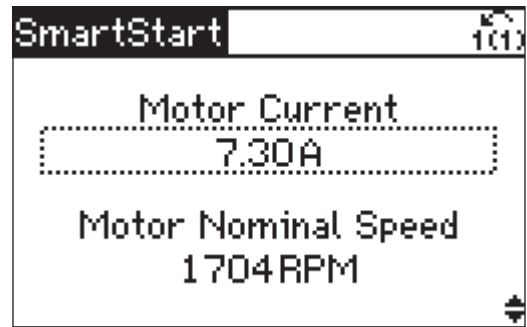
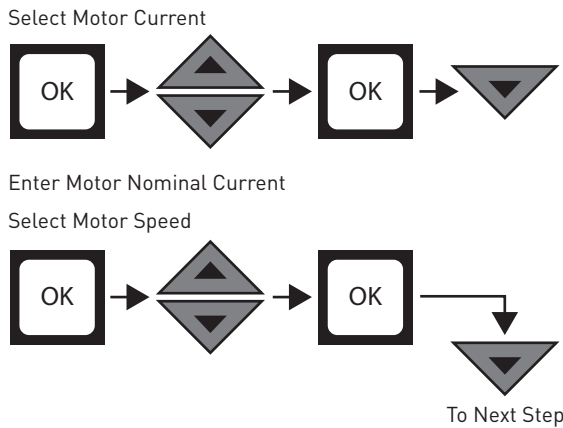

8

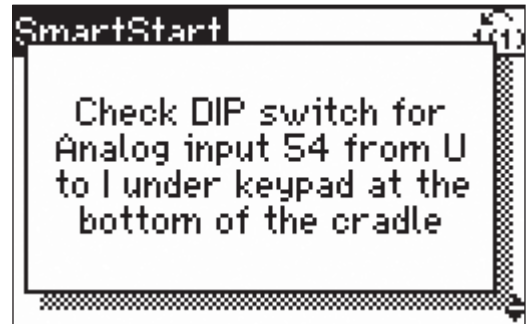

9



To Next Step

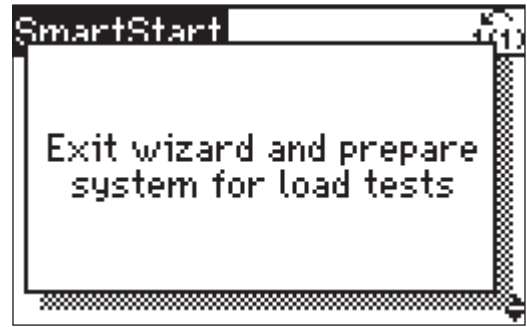

The next step runs the drive manually. That step (and the following steps) should be performed with no flow in the system (i.e. with a closed valve). The drive is learning about Sleep and Dry Run and to do this properly, there should not be any flow in the system – including flow into a pressure tank.

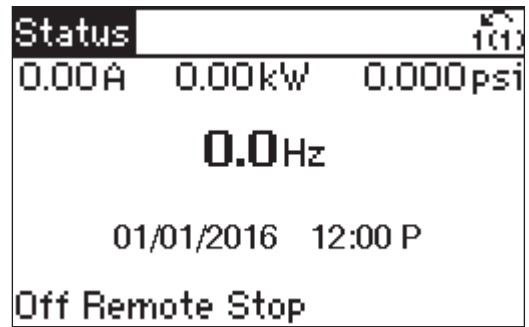

10

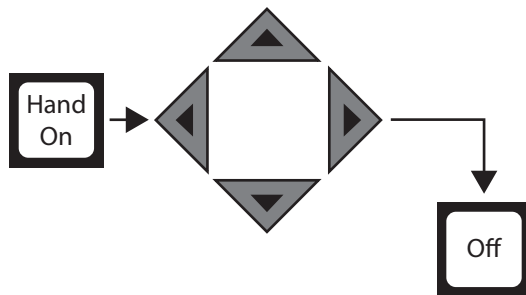

Ramp up the frequency (motor speed) until the display indicates 30 Hz. Verify motor rotation and fill pipes.
With a closed valve, slowly increase the frequency (motor speed) to 50 Hz. Once the drive has reached 50 Hz and a safe and stable pressure, press the OFF button. If the drive faults for Overpressure, reset the fault and go to Appendix A – Manual Sleep Setup to complete the drive setup.

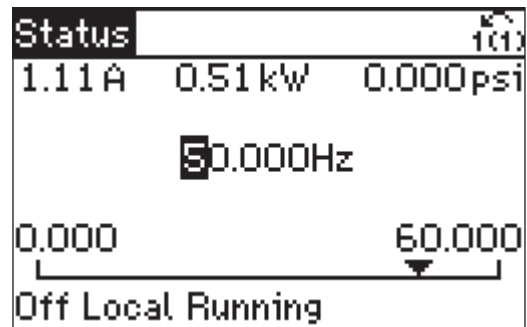

11



12

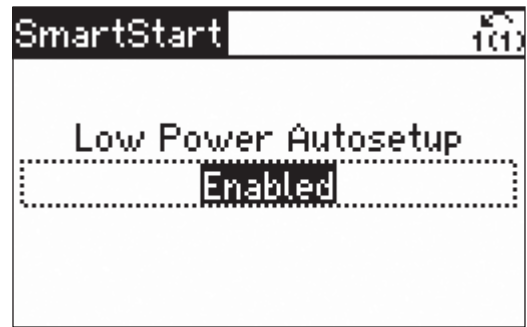
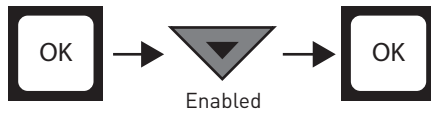

13

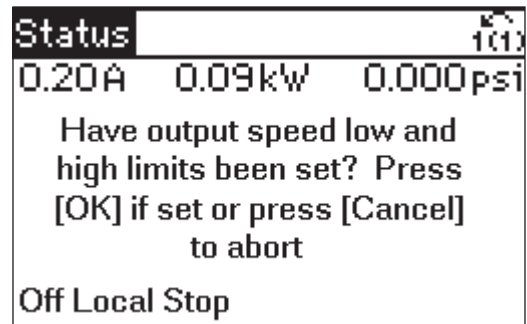

14 Make sure the system is primed and a valve is closed.

15

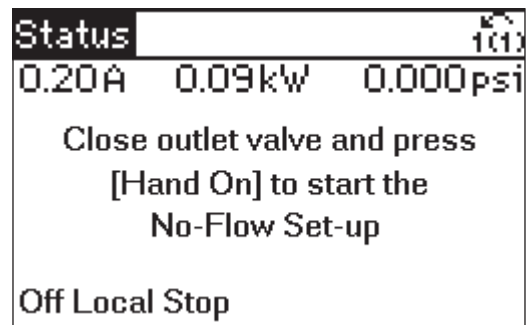

16 Wait while setup process completes

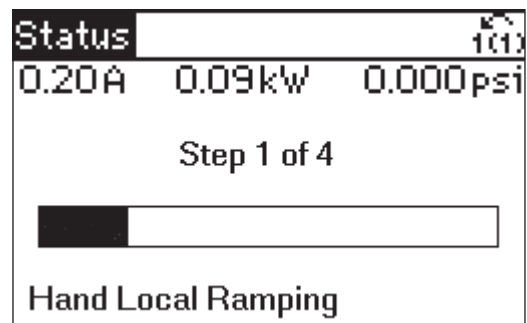

17

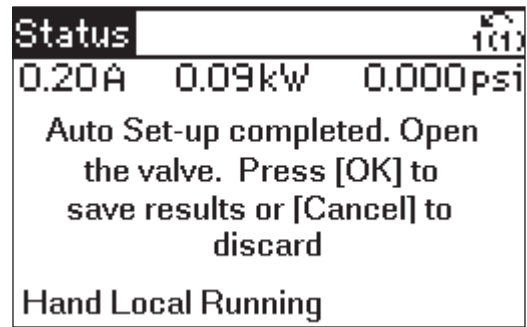

18

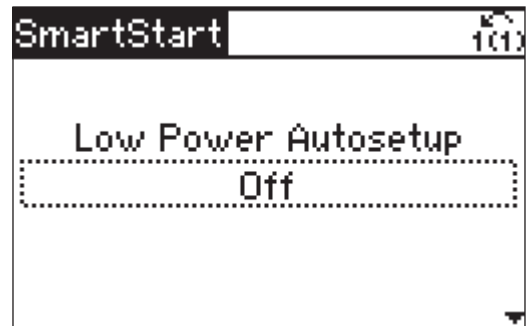

Wait while the process completes

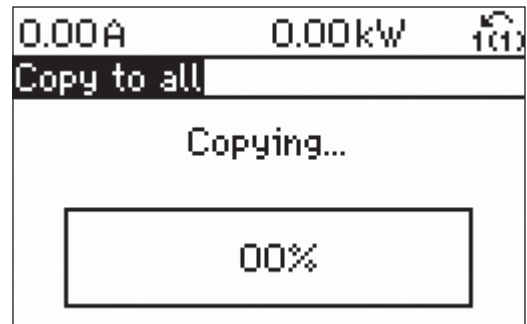

19



Adjust Live Zero Settings

20

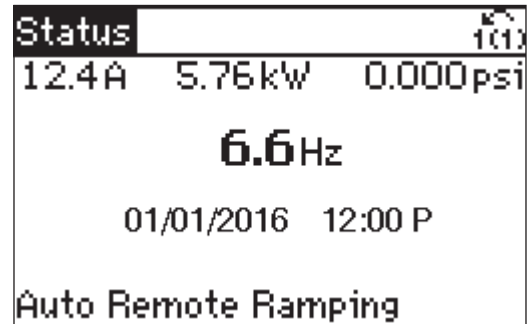

21

Use My Personal Menu to access commonly adjusted parameters: Setpoint, Ramp Times, Transducer Limits and PID and Pipe Fill Settings. See table below for a list of the parameters and their default settings.



Refer to Danfoss Operating Instructions (130R0336), Design Guide (130R0337), and Programming Guide (130R0335) for further details.

Parameter Name	Default Value
0-01 Language	English
3-41 Ramp 1 Ramp Up Time	5.0 Sec
3-42 Ramp 1 Ramp Down Time	5.0 Sec
3-84 Initial Ramp Time	1.0 sec for Submersible / Off for Above Ground
4-12 Motor Speed Low Limit	30 Hz for Submersible / 0 Hz for Above Ground
4-14 Motor Speed High Limit	60 Hz
6-25 Terminal 54 High Ref. / Feedb. Value	100 PSI
14-20 Reset Mode	Automatic Reset x 3
14-21 Automatic Restart Time	10 Min
20-21 Setpoint 1	60 PSI
20-93 PID Proportional Gain	2.00
20-94 PID Integral Time	8.00 Sec
22-24 No Flow Delay	10 Sec
22-27 Dry Pump Delay	10 Min
22-40 Minimum Run Time	1 Min
22-41 Minimum Sleep Time	30 Sec
22-44 Wake-Up Ref./FB Difference	10%
29-00 Pipe Fill Enable	Enabled
29-02 Pipe Fill Speed	45 Hz
29-03 Pipe Fill Time	60 Sec
29-05 Filled Setpoint	10 PSI

This process describes the steps necessary to manually set sleep parameters for systems that build unacceptable system pressure at 50Hz.

A1 Press Main Menu. Press OK at 0-** Operation / Display.

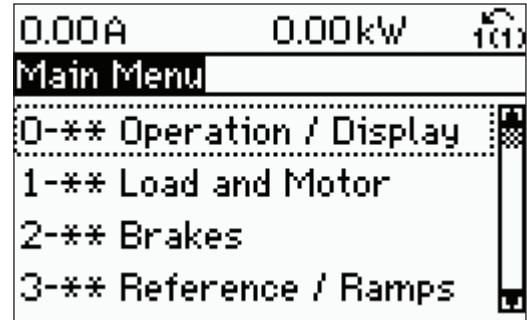

A2 Scroll down to 0-2* LCP Display and Press OK.

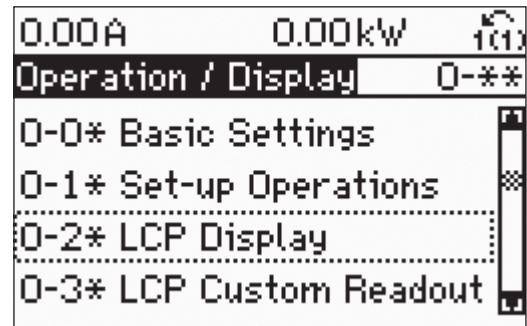

A3 For parameter 0-20, press OK to Highlight and change to "[1611] Power [hp]". Press OK to store the value and then Status to return to the main screen.

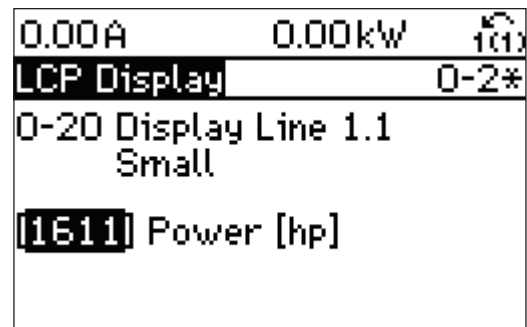

A4 Close a valve to make sure there is No Flow in the system.

A5 Press Hand On and scroll up to 30Hz.

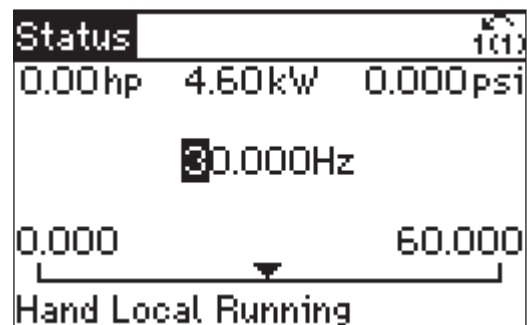

A6 When the system stabilizes, record the hp displayed in the upper left corner.

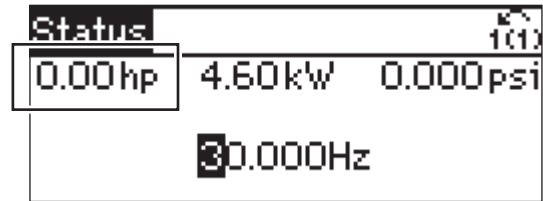

22-35 Low Speed Power = _____

A7 Slowly scroll up the speed (Hz) until a maximum safe pressure is achieved. Record the Speed (Hz) that the drive is running at and the hp displayed in the upper left corner.

22-37 High Speed Hz = _____

22-39 High Speed Power = _____

A8 Press Off.

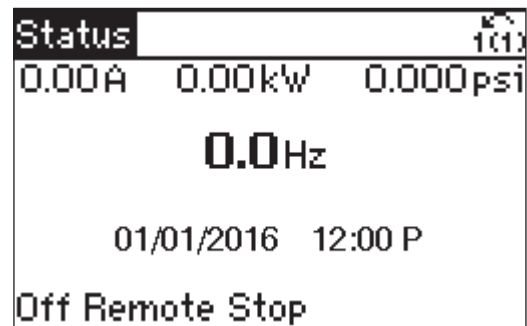

A9

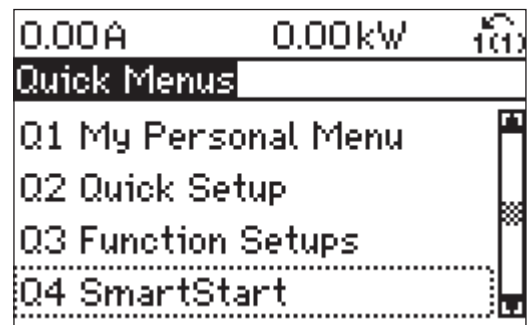

A10

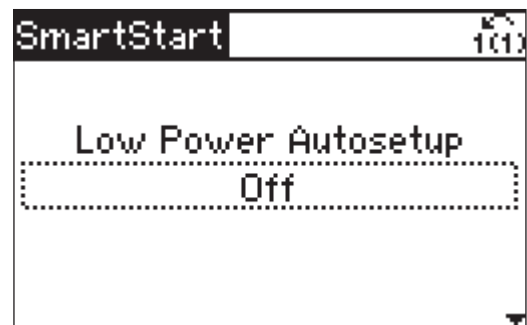

A11 When asked to run Lower Power setup again, Highlight and change to “No”. Press enter to save and Press Down Arrow.

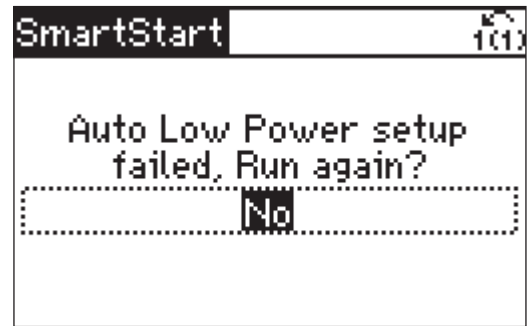

A12



Adjust Sleep Parameters

A13 Press Main Menu twice, navigate to 22-** and press OK.

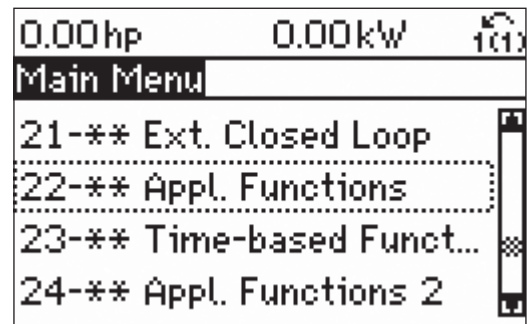

A14 Scroll to 22-2* No-Flow Detection and Press OK.

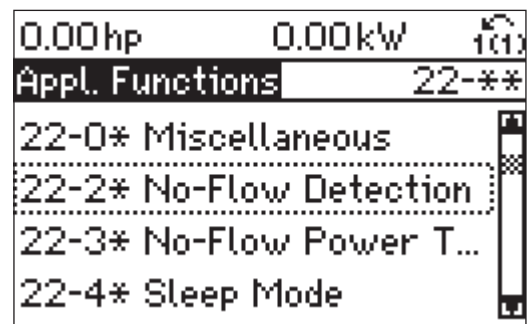

A15 Scroll to 22-21 Low Power Detection. Press OK to highlight, change to [1] Enabled and press OK to save.

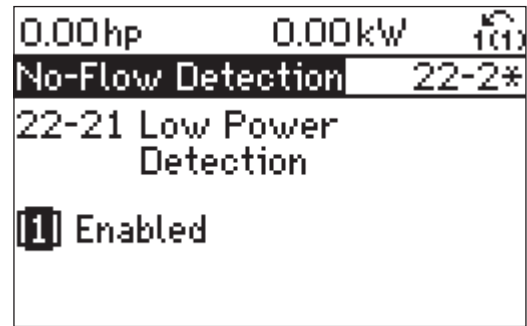

A16 Press the Back button and scroll down to 22-3* No-Flow Power T... and Press OK.

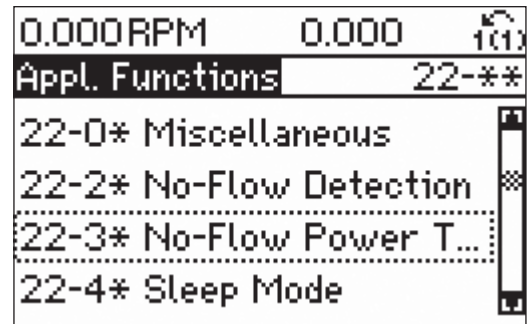

A17 Scroll to 22-37 High Speed Hz, press OK to highlight, change to speed noted in step 7, and press OK to save.

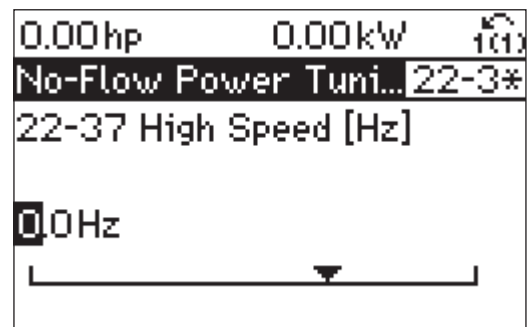

A18 Scroll to 22-39 High Speed Power, press OK to highlight, enter the value from step 7 above, and press OK to save.

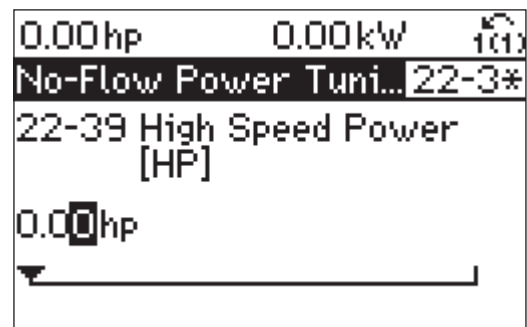

A19 Scroll to 22-33 Low Speed Hz, press OK to highlight, change to 30Hz, and press OK to save.

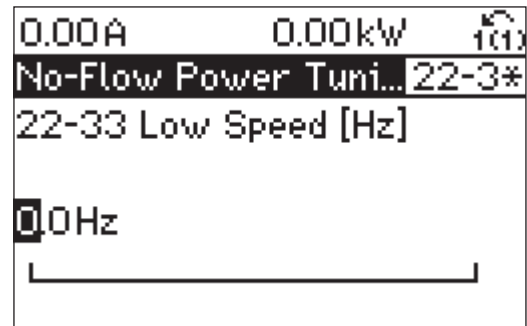

A20 Scroll to 22-35 Low Speed Power, press OK to highlight, enter the value from step 6 above, and press OK to save.

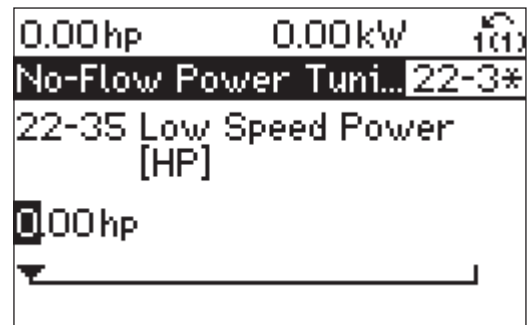

A21 Press Main Menu twice. Press OK at 0-** Operation / Display.

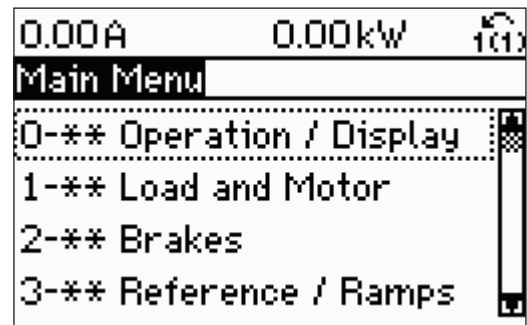

A22 Scroll down to 0-2* LCP Display and Press OK.

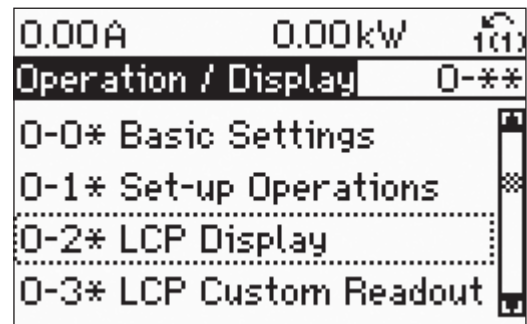

A23 For parameter 0-20, press OK to Highlight and change to “[2230] No Flow Power [hp]”. Press OK to store the value and then Status to return to the main screen.

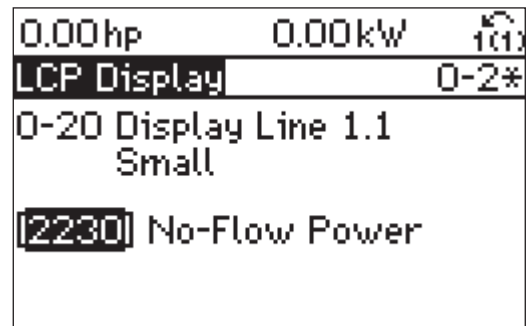

A24 The display now shows the power that triggers sleep in the upper left corner. The upper middle value shows the actual power being used.

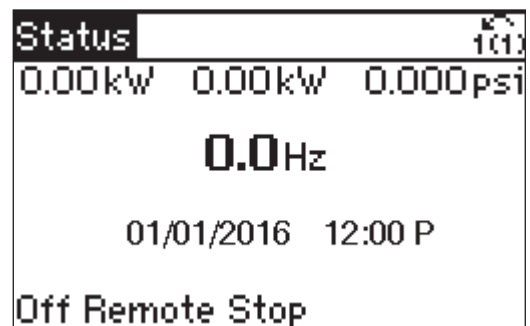

A25 Press Auto Start. Operate the drive in various conditions. Verify that the drive sleeps when it isn't using water and stays awake when it is.

A26 Sleep (No Flow)

When the drive is supposed to Sleep, the Sleep Power should be HIGHER than the Actual Power. This means the drive is not using power to pump water.

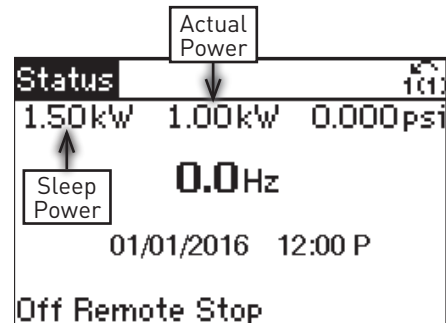

Awake (with Low Flow)

When the drive is supposed to Awake, the Actual Power should be HIGHER than the Sleep Power. This means the drive is using power to pump water.

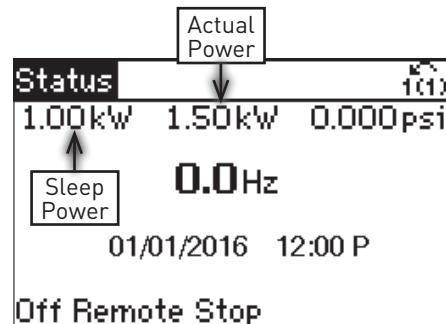

A27 If the drive is sleeping properly, go to Step 32. If it isn't, navigate to 22-31 Power Correction Factor on the drive and go to the next step to fine tune the sleep parameters.

A28 SLEEPS USING WATER

If the drive goes to sleep while still using water, parameter 22-31 Power Correction Factor needs to be adjusted. All systems are different. Consider changing from 100% to 96%.

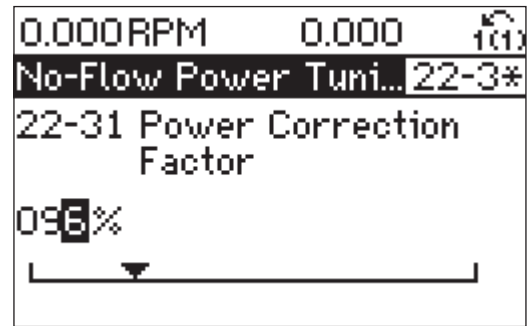

A29 Test the drive again. If the drive still sleeps while using water, continue to lower 22-31 Power Correction Factor until it stays awake while using water.

A30 WON'T SLEEP WHEN NOT USING WATER

If the drive stays awake while not using water, parameter 22-31 Power Correction Factor needs to be adjusted. All systems are different. Consider changing from 100% to 104%.

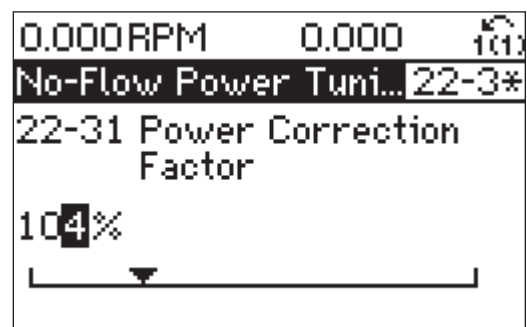

A31 Test the drive again. If the drive still stays awake when not using water, continue to raise 22-31 Power Correction Factor until it goes to sleep while not using water.

A32 Press Main Menu twice. Press OK at 0-** Operation / Display.

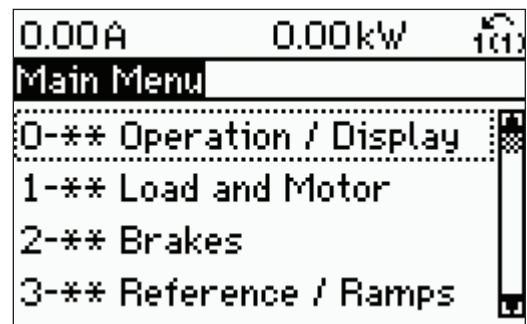

A33 Scroll to 0-2* LCP Display and Press OK.

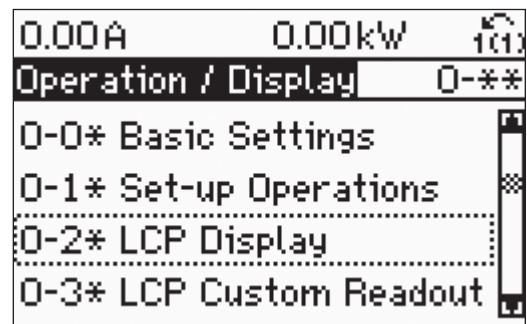

A34 For parameter 0-20, press OK to Highlight and change back to “[1614] Motor current”. Press OK to store the value and then Status to return to the main screen.

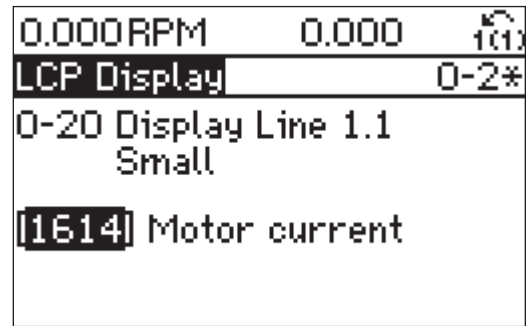

A35 Press and hold Main Menu for three (3) seconds.

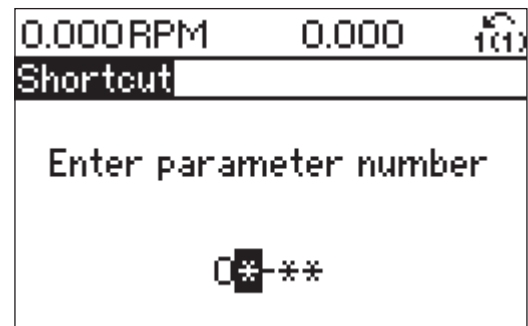

A36 Enter Parameter Number 06-00 using the arrow keys. Press OK.

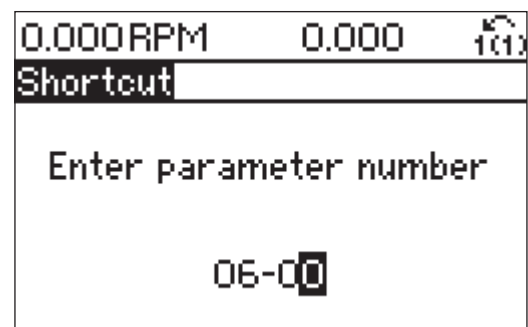

A37 Press OK to highlight and change to “000:01 min : s” using arrow keys. Press OK to save. Press the Down Arrow to navigate to 6-01 - Live Zero Timeout Function.

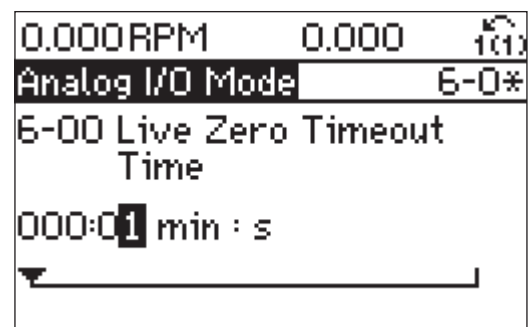

A38 Press OK to highlight and change to “[2] Stop” using arrow keys. Press OK to save. Press Status to return to main screen.

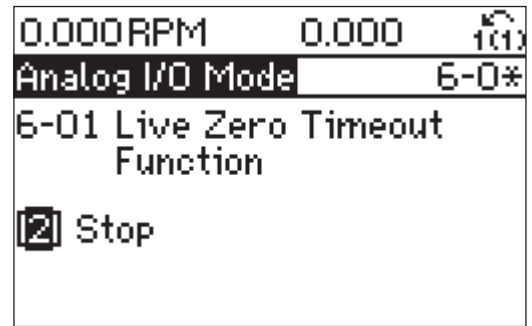

A39

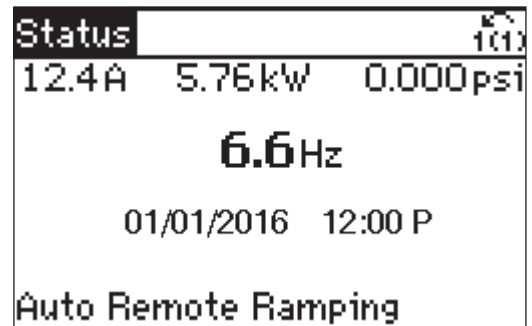

THIS PAGE INTENTIONALLY LEFT BLANK

THIS PAGE INTENTIONALLY LEFT BLANK

