

## SELECTION TABLES

### MODEL AP – BRAZED PLATE HEAT EXCHANGERS FOR RADIANT FLOOR APPLICATIONS

#### Connected to Boiler; 180°F Supply

Models	Radiant Floor: 80°F Return, 100°F Supply Boiler Return 150°F					Radiant Floor: 100°F Return, 120°F Supply Boiler Return 150°F					Radiant Floor: 120°F Return, 140°F Supply Boiler Return 160°F				
	Capacity	Side-A (Boiler)		Side-B (Radiant)		Capacity	Side-A (Boiler)		Side-B (Radiant)		Capacity	Side-A (Boiler)		Side-B (Radiant)	
	(Btu/hr)	(GPM)	PD (psi)	(GPM)	PD (psi)	(Btu/hr)	(GPM)	PD (psi)	(GPM)	PD (psi)	(Btu/hr)	(GPM)	PD (psi)	(GPM)	PD (psi)
AP4H-8	145,000	9.8	4.8	14.5	6.6	85,000	5.7	1.8	8.5	2.4	55,000	5.6	1.8	5.5	1.0
AP4H-10	185,000	12.6	4.5	18.5	6.9	120,000	8.1	2.0	12.1	3.0	80,000	8.1	2.0	8.1	1.3
AP4H-12	220,500	15.0	4.1	22.1	6.8	155,000	10.5	2.1	15.6	3.4	105,000	10.7	2.2	10.6	1.6
AP4H-14	255,000	17.3	3.8	25.6	6.7	200,000	13.6	2.4	20.1	4.2	130,000	13.3	2.3	13.1	1.8
AP4H-16	289,000	19.7	3.7	29.0	6.7	225,000	15.3	2.3	22.6	4.1	175,000	17.9	3.0	17.7	2.5
AP4H-20	360,000	24.5	3.5	36.1	6.7	300,000	20.4	2.5	30.2	4.7	232,000	23.7	3.3	23.5	2.8
AP4H-24	435,000	29.6	3.5	43.6	7.0	365,000	24.8	2.5	36.8	4.9	275,000	28.1	3.2	27.8	2.8
AP4H-30	525,000	35.8	3.3	52.7	6.9	500,000	34.0	3.1	50.4	6.1	325,000	33.2	2.9	32.9	2.7
AP4H-36	610,000	41.5	3.3	61.2	7.0	585,000	39.8	3.0	59.0	6.3	450,000	46.0	4.0	45.6	3.8
AP4H-40	650,000	44.3	3.2	65.2	6.8	625,000	42.6	3.0	63.0	6.2	515,000	52.7	4.4	52.2	4.2
AP4H-50	765,000	51.1	3.2	75.6	7.0	750,000	51.1	3.2	75.6	7.0	575,000	58.8	4.1	58.3	4.0
AP4H-60	810,000	55.2	3.1	81.3	6.9	815,000	55.5	3.2	82.2	6.9	675,000	69.1	4.8	68.4	4.8
AP4H-70	840,000	57.2	3.1	84.3	6.9	840,000	57.2	3.1	84.7	6.8	825,000	84.4	6.6	83.6	6.6
AP4H-80	915,000	62.3	3.6	91.9	7.9	915,000	62.3	3.6	91.9	7.8	915,000	93.7	7.9	92.7	7.9

#### NOTES:

- Larger units are available.
- Working Pressure: 300 psig.

Models	Radiant Floor: 80°F Return, 100°F Supply Boiler Return 150°F					Radiant Floor: 100°F Return, 120°F Supply Boiler Return 150°F					Radiant Floor: 120°F Return, 140°F Supply Boiler Return 160°F				
	Capacity	Side-A (Boiler)		Side-B (Radiant)		Capacity	Side-A (Boiler)		Side-B (Radiant)		Capacity	Side-A (Boiler)		Side-B (Radiant)	
	(Btu/hr)	(GPM)	PD (psi)	(GPM)	PD (psi)	(Btu/hr)	(GPM)	PD (psi)	(GPM)	PD (psi)	(Btu/hr)	(GPM)	PD (psi)	(GPM)	PD (psi)
AP57H-20	500,000	34.0	4.9	50.2	9.8	515,000	35.1	5.2	51.9	9.8	500,000	51.2	10.0	50.7	8.9
AP57H-24	610,000	41.5	4.9	61.2	10.1	625,000	42.6	5.2	63.0	10.0	610,000	62.4	10.0	61.8	9.2
AP57H-30	760,000	51.8	4.8	76.3	10.1	770,000	52.5	4.9	77.6	9.8	770,000	78.8	9.9	78.0	9.4
AP57H-36	910,000	62.0	4.7	91.4	10.1	930,000	63.4	4.9	93.8	10.0	940,000	96.2	10.1	95.3	9.8
AP57H-40	1,005,000	68.5	4.6	100.9	10.0	1,030,000	70.2	4.8	103.9	10.0	1,040,000	106.5	10.0	105.4	9.8
AP57H-50	1,240,000	84.5	4.5	124.5	10.0	1,250,000	85.2	4.6	126.1	9.7	1,300,000	133.1	10.0	131.8	10.0
AP57H-60	1,450,000	98.8	4.4	145.6	9.8	1,500,000	102.2	4.6	151.3	9.9	1,500,000	153.6	9.5	152.1	9.6
AP57H-70	1,670,000	113.8	4.4	167.7	9.9	1,720,000	117.2	4.6	173.5	10.0	1,750,000	179.2	9.8	177.4	9.9
AP57H-80	1,875,000	127.8	4.4	188.3	10.0	1,925,000	131.2	4.6	194.2	10.1	1,950,000	199.7	9.8	197.7	10.0
AP57H-90	2,050,000	139.8	4.4	205.9	10.0	2,100,000	143.2	4.6	211.8	10.1	2,140,000	219.1	9.9	216.9	10.1
AP57H-100	2,200,000	150.0	4.4	221.0	10.0	2,250,000	153.4	4.6	226.9	10.0	2,250,000	230.4	9.5	228.1	9.7

#### NOTES:

- Larger units are available.
- Design Working Pressure: 450 psig.

Many radiant floor applications utilize Brazed Plate heat exchangers to reduce the overall cost of the radiant floor system installation. This is possible when using cast iron boilers and radiant tubing (with lower cost, no oxygen barrier) and for applications where isolation of the boiler to radiant floor loops are needed. These actions simplify installation and minimize costs.

Brazed Plate models also make it possible to interface steam boilers to radiant floor systems, both low pressure and high pressure steam systems (up to 300 psi) using the APSMO series.

Another strong application is using a domestic hot water heater to provide heat to a radiant floor system bathroom radiant floor, or for add-on projects. This is easily accomplished using a Brazed Plate model to isolate the domestic water from the radiant floor loop.

To select a Heat Exchanger for a **Boiler to Radiant Floor** application:

Step 1: Select the BTUH capacity required.

Step 2: Select the Heat Exchanger model from the table shown.

*Use AP models for water boilers.*

*Use the closest matching APSMO model for steam boilers.*

Step 3: Select your pump(s) based on the minimum recommended flow rates from the table.

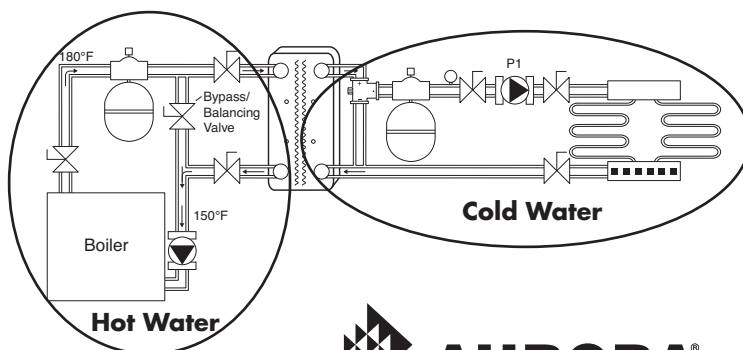

# AURORA 1081BP SERIES

## SELECTION TABLES

### MODEL AP – BRAZED PLATE HEAT EXCHANGERS FOR RADIANT FLOOR – HOT WATER HEATERS

To select a Heat Exchanger for a **Hot Water Heater to Radiant Floor** application:

Step 1: Select the BTUH capacity required.

Step 2: Select the Heat Exchanger model using the second column from the table on page 8. This allows a 130°F water heater to provide 120°F supply water to the radiant floor mixing loop.  
 Use AP models for city water and softened water.  
 Use APSMO models for hard water, well (ground) water and coastal waters.

Example: For a 40,000 BTUH requirement, select model AP4H-20 (1" MPT). If well water, use the closest matching model, APSMO5x12-20 (1" MPT) from page 8.

Step 3: Select your pump(s) based on the minimum recommended flow rates from the table.

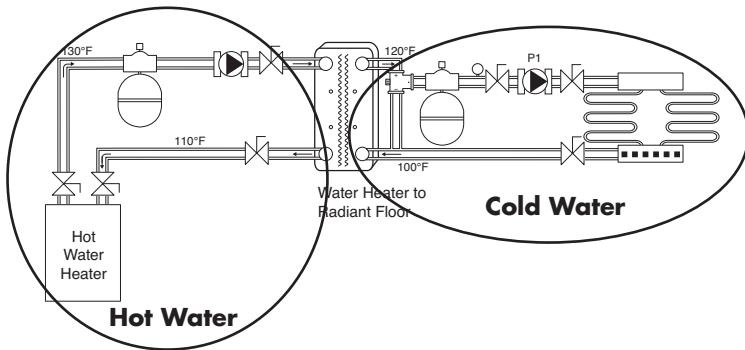

#### Hot Water Heater; 140°F Supply, 120°F Return

Models	Radiant Floor: 100°F Return, 120°F Supply				
	Capacity (Btu/hr)	Side-A (Boiler)		Side-B (Radiant)	
		(GPM)	PD (psi)	(GPM)	PD (psi)
AP4H-8	32,000	3.2	3.2	3.2	1.9
AP4H-10	42,500	4.3	3.2	4.2	2.2
AP4H-12	55,000	5.5	3.4	5.5	2.5
AP4H-14	80,500	8.1	5.0	8.1	3.8
AP4H-16	93,500	9.4	4.9	9.4	3.9
AP4H-20	120,000	12.1	4.9	12.1	4.1
AP4H-24	146,000	14.8	4.9	14.7	4.3
AP4H-30	186,500	18.9	5.0	18.8	4.5
AP4H-36	225,000	22.8	5.0	22.6	4.6
AP4H-40	250,000	25.3	5.0	25.2	4.7
AP4H-50	305,000	30.9	4.9	30.7	4.6
AP4H-60	359,000	36.4	4.9	36.2	4.7
AP4H-70	410,000	41.5	5.0	41.3	4.9
AP4H-80	450,000	45.6	5.0	45.3	4.9

**NOTES:**

1. Larger units are available.
2. Design Working Pressure: 300 psig.
3. All units are standard models.
4. Made with 316L stainless alloy, copper brazed.
5. Stainless steel MPT fittings and mounting stud bolts.

**Piping:** Follow standard piping practices recommended by the radiant floor system manufacturer.

**Controls:** A three-way tempering valve is required to control the radiant floor loop temperature.

**Start-up:** Adjust the three-way tempering valve to obtain the desired radiant loop set point. Then, with the radiant floor loop at or near full load, adjust the boiler side bypass/balancing valve to obtain the proper water temperature return to the boiler (i.e. 150°F).

## SELECTION TABLES

### MODEL AP – BRAZED PLATE HEAT EXCHANGERS FOR DOMESTIC HOT WATER HEATING APPLICATIONS

Brazed Plate heat exchangers are ideal and offer a compact, high output capacity for Domestic Hot Water heating applications. These heat exchangers offer substantial advantages over shell & tube, tank & coil, U-tube bundles and other older technologies when used in both hot water boiler (AP series) and steam applications (APSMO series). These advantages include the unit being easier to install, rig and maintain at 1/5 the size and weight with a faster response and long life use.

Brazed Plate models are excellent for both new construction and replacement applications.

Three types of piping installations are typical:

**Recirc to Tank Only:** A recirc pump to the hot water tank is typical in most residential and light commercial applications.

**Recirc Loop in Building:** A recirc loop is used, with or without a hot water storage tank, for many commercial and industrial applications.

**Instantaneous:** Instantaneous hot water heating can be used in a few installations.

To select a Heat Exchanger for all three of the above

**Domestic Hot Water Heating** applications:

Step 1: Select the BTUH capacity required.

Step 2: Select the Heat Exchanger model from the table shown.

*Use AP models for water boilers.*

*Use APSMO models for steam boilers.*

Step 3: Select your pump(s) based on the minimum recommended flow rates from the table. NOTE: Table 1 is based on

50°F–140°F standard temperature rise, and the minimum flow rates are 1.5x the corresponding flow for this temperature rise, to maximize BTUH output, and minimize scaling.

If Instantaneous Hot Water Heating: Same Heat Exchanger applies, but no minimum flow required.

Models	Boiler Water: 180°F Supply, 160°F Return Domestic Water: 50°F Return, 140°F Supply					
	# of Plates	Capacity	Side A (Boiler)		Side B (Domestic)	
		(BTU/hr)	(GPM)	PD (psi)	(GPM)	PD (psi)
AP2H-8	8	37,792	3.9	5.0	0.8	0.2
AP2H-10	10	49,804	5.1	5.0	1.1	0.2
AP2H-12	12	60,546	6.2	5.0	1.4	0.2
AP2H-14	14	72,265	7.4	5.0	1.6	0.3
AP2H-16	16	82,030	8.4	5.0	1.8	0.2
AP2H-20	20	100,780	10.3	5.0	2.3	0.3
AP2H-24	24	117,186	12.0	5.0	2.6	0.3
AP2H-30	30	136,717	14.0	5.0	3.1	0.3
AP2H-40	40	161,130	16.5	5.0	3.6	0.3
AP2H-50	50	175,779	18.0	5.0	3.9	0.3
AP4H-8	8	42,968	4.4	5.0	1.0	0.2
AP4H-10	10	57,616	5.9	5.0	1.3	0.2
AP4H-12	12	72,265	7.4	5.0	1.6	0.2
AP4H-14	14	85,936	8.8	5.0	1.9	0.2
AP4H-16	16	110,584	10.3	5.0	2.2	0.2
AP4H-20	20	127,928	13.1	5.0	2.9	0.3
AP4H-24	24	156,248	16.0	5.0	3.5	0.3
AP4H-30	30	196,286	20.1	5.0	4.4	0.3
AP4H-36	36	235,348	24.1	5.0	5.3	0.3
AP4H-40	40	259,762	26.6	5.0	5.8	0.3
AP4H-50	50	320,308	32.8	5.0	7.2	0.3
AP4H-60	60	375,971	38.5	5.0	8.4	0.3
AP4H-70	70	423,822	43.4	5.0	9.5	0.3
AP4H-80	80	472,405	48.4	5.0	10.6	0.3
AP4H-90	90	510,735	52.3	5.0	11.4	0.3
AP4H-100	100	544,914	55.8	5.0	12.2	0.3
AP4H-110	110	574,406	58.8	5.0	12.8	0.3
AP4H-120	120	603,019	61.8	5.0	13.5	0.3
AP57H-20	20	202,145	20.7	5.0	4.5	0.3
AP57H-24	24	247,067	25.3	5.0	5.5	0.3
AP57H-30	30	314,449	32.2	5.0	7.0	0.3
AP57H-36	36	385,063	39.4	5.0	8.6	0.3
AP57H-40	40	425,165	43.5	5.0	9.5	0.3
AP57H-50	50	532,219	54.5	5.0	11.9	0.3
AP57H-60	60	640,616	65.6	5.0	14.3	0.3
AP57H-70	70	734,364	75.2	5.0	16.4	0.3
AP57H-80	80	832,019	85.2	5.0	18.6	0.3
AP57H-90	90	927,721	95.0	5.0	20.7	0.3
AP57H-100	100	1,025,376	105.0	5.0	22.9	0.3
AP57H-110	110	1,101,546	112.8	5.0	24.6	0.3
AP57H-120	120	1,186,506	121.5	5.0	26.5	0.3
AP57H-130	130	1,269,519	130.0	5.0	28.4	0.3
AP57H-140	140	1,342,754	137.5	5.0	30.0	0.3
AP57H-150	150	1,416,971	145.1	5.0	31.7	0.3
AP57H-160	160	1,484,353	152.0	5.0	33.2	0.3
AP57H-170	170	1,545,876	158.3	5.0	34.5	0.3
AP57H-180	180	1,601,539	164.0	5.0	35.8	0.3
AP57H-190	190	1,660,132	170.0	5.0	37.1	0.3
AP57H-200	200	1,713,842	175.5	5.0	38.3	0.3

NOTE:

Larger models are available.

# AURORA 1081BP SERIES

## SELECTION TABLES

### MODEL AP – BRAZED PLATE HEAT EXCHANGERS FOR DOMESTIC HOT WATER HEATING APPLICATIONS

**Piping:** Tee(s) on the output side of the HX are recommended for convenience in case future chemical descaling and cleaning is required.

**Controls:** Typical control of the pumps (Recirc to Tank only) should use an aqua stat in the hot water storage tank to maintain set point temperature (i.e. 130°F).

**Controls for Recirc Loops:** For recirculated domestic hot water systems (i.e. apartments, hospitals, factories and office buildings), a motorized three-way mixing valve is REQUIRED on the boiler side and should be modulated based on water temperature *leaving* the heat exchanger into the domestic water loop. The hot water loop pump runs continuously; this maintains the hot water set point for the loop and storage tank. The recirc pump should flow 100% of the return loop water through the heat exchanger, then to the storage tank (if required; depends on boiler capacity) at all times to minimize scaling and maximize BTUH output. City water inlet is recommended *before* the heat exchanger and *after* the pump to maximize the heat exchanger capacity.

**Controls for Instantaneous Water Heating:** A three-way tempering valve is required and an anti-scalding safety device must be installed. The boiler pump should run continuously.

**Controls for Steam Systems:** A modulating steam valve and proper steam trapping is required.

**Startup:** The bypass/balancing valve should be adjusted at full load to obtain the proper return water temperature to the boiler.

For applications with a recirc domestic hot water loop, the modulating three-way valve should be adjusted so that it maintains proper domestic water temperature and does not hunt or overshoot. Slow to medium response rate is recommended.

**Diagram 1-Recirc to Tank**

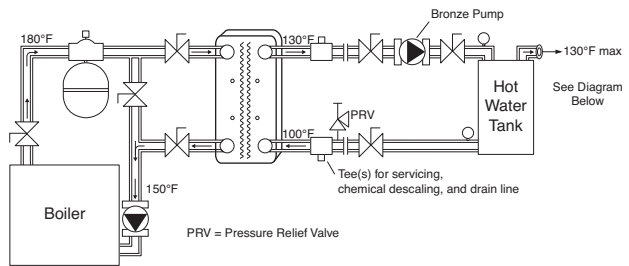

**Diagram 2-Recirc to Building Loop**

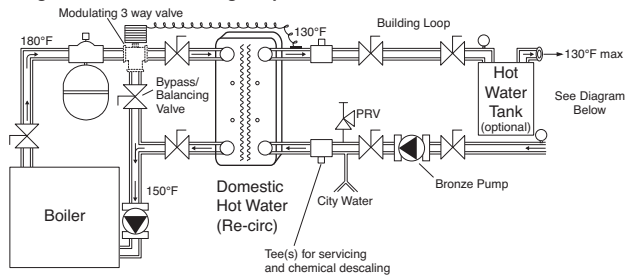

**Diagram 3-Instantaneous**

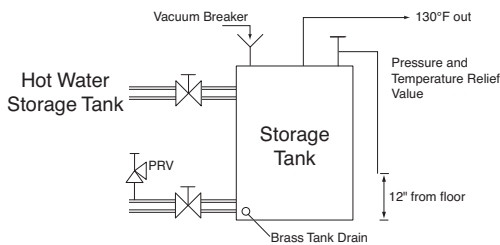
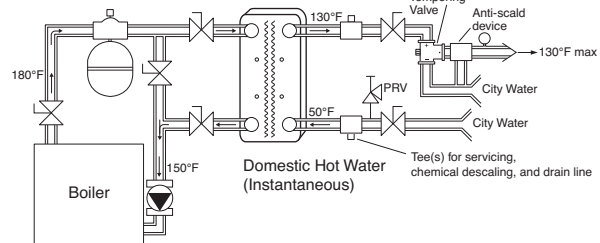

**NOTES:**  
 Storage tanks over 120 gals. or 200,000 BTU  
 must have ASME Certification.

## SELECTION TABLES

### MODEL APDW – DOUBLE WALL, VENTED HEAT EXCHANGERS FOR DOMESTIC HOT WATER HEATING APPLICATIONS

The APDW model is a Double Wall, Vented Heat Exchanger designed to meet local and state plumbing codes for double separation of potable water from boiler water and other non-potable fluids. As a cost effective, full range heat exchanger, the APDW model is a true Double Wall Vented design with double wall plates and double seal fluid ports, both of which have positive leak detection. The APDW model also has full thickness 316L copper brazed plates for longer product usage and reliability. Compact and easy to install, the APDW model is ideal for new construction or shell & tube replacement. U.L. Listed. Optional ASME Code.

**Piping:** Tee(s) on the output side of the HX are recommended for convenience in case future chemical descaling and cleaning is required.

**Controls:** Typical control of the pumps (Recirc to Tank only) should use an aqua stat in the hot water storage tank to maintain set point temperature (i.e. 130°F).

**Controls for Recirc Loops:** For recirculated domestic hot water systems (i.e. apartments, hospitals, factories and office buildings), a motorized three-way mixing valve is required on the boiler side and should be modulated based on water temperature *leaving* the heat exchanger into the domestic water loop. The hot water loop pump runs continuously; this maintains the hot water set point for the loop and storage tank. The recirc pump should flow 100% of the return loop water through the heat exchanger, then to the storage tank (if required; depends on boiler capacity) at all times to minimize scaling and maximize BTUH output. City water inlet is recommended *before* the heat exchanger and *after* the pump to maximize the heat exchanger capacity.

**Controls for Instantaneous Water Heating:** A three-way tempering valve is required and an anti-scalding safety device must be installed. The boiler pump should run continuously.

**Controls for Steam Systems:** A modulating steam valve and proper steam trapping is required.

**Start-up:** The bypass/balancing valve should be adjusted at full load to obtain the proper return water temperature to the boiler.

For applications with a recirc domestic hot water loop, the modulating three-way valve should be adjusted so that it maintains proper domestic water temperature and does not hunt or overshoot. Slow to medium response rate is recommended.

**Diagram 1-Recirc to Tank**

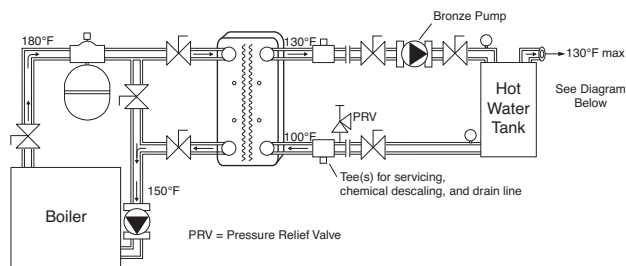

Models	Boiler Water: 180°F Supply, 150° Return Domestic Water: 50°F Return, 140°F Supply					
	# of Plates	Capacity	Side A (Boiler)		Side B (Domestic)	
		(BTU/hr)	(GPM)	PD (psi)	(GPM)	PD (psi)
APDW10-6	6	27,500	1.8	5.0	0.6	0.4
APDW10-10	10	55,000	3.7	5.0	1.2	0.8
APDW10-14	14	82,000	5.5	5.0	1.8	0.8
APDW10-18	18	110,000	7.5	5.0	2.4	1.2
APDW10-22	22	135,500	9.2	5.0	3.0	1.2
APDW10-30	30	177,500	12.1	4.4	3.9	1.2
APDW10-42	42	240,000	16.3	4.0	5.3	1.2
APDW10-50	50	283,000	19.2	4.0	6.3	1.2
APDW10-62	62	347,000	23.6	4.0	7.7	1.2
APDW10-74	74	411,000	28.0	4.0	9.1	1.2
APDW10-94	94	515,000	35.1	4.0	11.5	1.2
APDW10-110	110	600,000	40.9	4.0	13.4	1.2
APDW10-134	134	730,000	49.7	4.0	16.3	1.2
APDW10-154	154	839,500	57.2	4.0	18.7	1.2
APDW10-198	198	1,075,000	73.3	4.0	24.0	1.2

**NOTES:**

- Design Working Pressure: 450 psig.
- All units are standard models.
- Made with 316L stainless alloy; copper brazed.
- Stainless steel MPT fittings and mounting stud bolts.
- For ASME versions, put "UM" after the model number.  
Example: APDW10-50 (1-1/2" MPT)-UM
- For International versions, connections are BSPT.  
Example: APDW10-50 (1-1/2" BSPT)

**Diagram 2-Recirc to Building Loop**

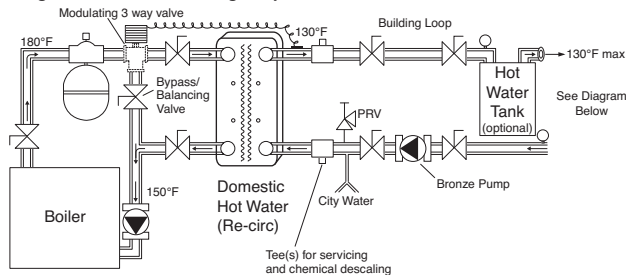

**Diagram 3-Instantaneous**

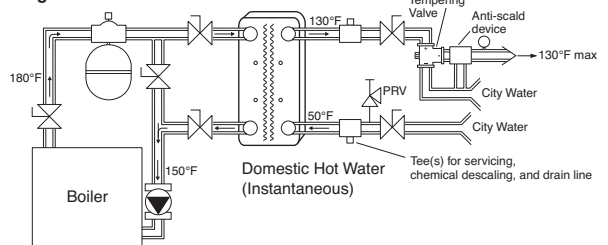

# AURORA 1081BP SERIES

## SELECTION TABLES MODEL APSMO – BRAZED PLATE HEAT EXCHANGERS FOR SWIMMING POOLS

1∞F/hr Heat Up Rate					2∞F/hr Heat Up Rate			
Models	Pool Capacity	Boiler Output Required	Boiler Side Minimum	Pressure Drop	Models	Boiler Output Required	Boiler Side Minimum	Pressure Drop
	(Gallons)	(Btu/hr)	(GPM)	(psig)		(Btu/hr)	(GPM)	(psig)
APSMO5X12-4	1,000	8,345	2	8.7	APSMO5X12-4	16,690	2	8.7
	2,000	16,690	2	8.7	APSMO5X12-6	33,380	2	2.4
APSMO5X12-6	4,000	33,380	2	2.4	APSMO5X12-8	66,760	4	4.1
	6,000	50,070	3	5.1	APSMO5X12-10	100,140	7	6.9
APSMO5X12-8	8,000	66,760	4	4.1		133,520	9	11.0
	APSMO5X12-10	10,000	83,450	6	5.1	APSMO5X12-16	166,900	11
12,000		100,140	7	6.9	200,280		13	7.8
APSMO5X12-16	15,000	125,175	8	8.0	APSMO5X12-20	250,350	17	8.1
	20,000	166,900	11	5.7	APSMO5X12-24	333,800	22	9.2
APSMO5X12-20	25,000	208,625	14	9.0	APSMO5X12-30	417,250	28	9.3
	30,000	250,350	17	8.1	APSMO5X12-40	500,700	33	7.4
APSMO5X12-24	35,000	292,075	18	9.1		584,150	36	8.7
	APSMO5X12-30	40,000	333,800	19	6.9	APSMO5X12-50	667,600	38
45,000		375,525	21	5.4	751,050		43	8.4
APSMO5X12-40	50,000	417,250	24	7.0	APSMO5X12-60	834,500	48	7.6
	60,000	500,700	29	5.8	APSMO5X12-70	1,001,400	57	8.4
APSMO5X12-50	70,000	584,150	33	7.5	APSMO10X20L-20	1,168,300	60	13.6
	80,000	667,600	38	6.6	APSMO10X20L-24	1,335,200	69	12.1
APSMO5X12-60	90,000	751,050	43	8.3	APSMO10X20L-30	1,502,100	77	9.8
	100,000	834,500	48	7.6		1,669,000	86	11.7
APSMO5X12-70	125,000	1,043,125	60	9.2	APSMO10X20L-36	2,086,250	107	12.5

**NOTES:**

1. Typical Design Conditions: 180°F boiler water and 80°F pool water to the heat exchanger.
2. Install a zinc anode on the swimming pool side piping when using an electronic chlorinator.
3. Bypass/balancing valve on swimming pool side of heat exchanger **REQUIRED** to allow for full pool pump flow.
4. Swimming pool side pressure drop for all models ranges from 4.0 psig or higher, depending on setting of bypass/balancing valve.
5. For 160°F boiler water, increase product model size by 1.5 (i.e. APSMO5x12-16 at 180°F, use APSMO5x12-24 at 160°F).
6. For 200°F boiler water and steam, use the same model size and multiply minimum boiler GPM by 0.60.
7. Materials Used: 254SMO stainless alloy; nickel braze; stainless steel MPT fittings and mounting studs.
8. Design Working Pressure: 300 psig.
9. Conversion from psig to ft-head: Multiply psig value by 2.31.

Selecting a Brazed Plate Heat Exchanger for Swimming Pool applications is based on the Total Pool Capacity (Gallons), Heat Loss of the pool and the desired Heat Up Rate. APSMO models are designed for Swimming Pool applications where chemically treated water and biological elements are present.

**NOTE:** APSMO series Heat Exchangers use a special 254SMO stainless alloy and **MUST** be used in swimming pool environments. Materials such as 316 stainless steel will corrode and fail due to chlorine and other chemical and biological elements typical in pool water.



## SELECTION TABLES

### MODEL APSMO – BRAZED PLATE HEAT EXCHANGERS FOR SWIMMING POOLS & SPAS

To select a Heat Exchanger for

#### Boiler to Pool Water Heating:

Step 1: Select the desired Heat Up Rate.

Pool Use	Heat Up Rate
Periodic Use Only (weekends, holidays)	2°F/hour
Extended Use (summer season)	1°F/hour

Step 2: Determine Pool Capacity.

#### Rectangular Pools

$$\text{Capacity (gallons)} = \frac{\text{Length (ft)} \times \text{Width (ft)} \times \text{Average Depth (ft)} \times 7.5 \text{ gallons/cu ft}}$$

#### Circular Pools

$$\text{Capacity (gallons)} = \frac{\text{Diameter}^2 \text{ (ft)} \times \text{Average Depth (ft)} \times .785 \times 7.5 \text{ gallons/cu ft}}$$

Step 3: Select the Heat Exchanger and Boiler Output Required.

From the Selection table, based on the Pool Capacity (Gallons), select the appropriate heat exchanger and boiler capacity based on the Heat Up Rate.

Example: For a 15x30 ft pool, averaging 5.5 ft deep, the pool capacity is 18,563 gallons. Using the Selection table, a 1°F/hr heat up rate requires 166,900 BTUH and a APSMO5x12-16 heat exchanger.

Step 4: Check for Heat Loss to Surroundings.

$$\text{Heat Loss (BTUH)} = 12 \times \frac{\text{Pool Surface Area (sq ft)} \times (\text{Desired Pool Temp (°F)} - \text{Coldest Ambient Temp During Use (°F)})}{\text{Heat Transfer Coefficient}}$$

Use this calculation to verify that the Boiler Output exceeds the heat loss to surroundings.

**Piping:** Pools and Spas always have high water flow rates, from 30-50 GPM for a typical residential pool to higher GPMs for commercial applications. Because the APSMO model is a high efficiency heat exchanger and does not require the full pool GPM flow, a bypass/balancing valve is required to bypass 50%-80% of the pool water. The bypass/balancing valve should be adjusted and permanently set at startup.

Chemical feeds MUST be downstream from the heat exchanger. A check valve should be installed to prevent backflow of chemicals into the heat exchanger when the pump is not in operation.

**Controls:** Temperature control of the pool should be based on a return water temperature stat, controlling (on/off) the boiler and boiler pump. Temperature control of the 90°F-100°F feed to the pool should be controlled by permanent adjustment of the bypass/balancing valve.

**Startup:** Start up the system and adjust the pool side bypass/balancing valve so that the pool initially heats up no faster than 2°F/hr. After the pool reaches approximately 78°F-80°F and the boiler water enters at 180°F, adjust the pool side bypass/balancing valve to obtain 90°F-100°F water to the pool. Then, adjust the boiler bypass/ balancing valve so that approximately 150°F water returns to the boiler.

**NOTE:** Install a zinc anode on the swimming pool/spa side piping when using an electronic chlorinator.

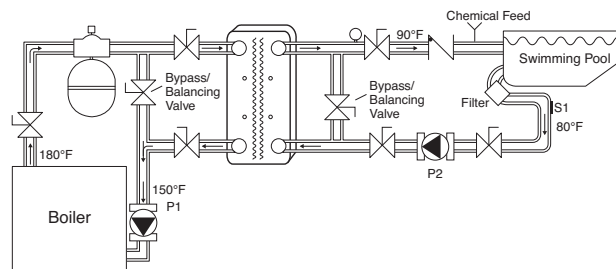

#### SPAS:

Models	2°F/Hr Heat up Rate, plus Aeration		
	Spa Capacity (Gallons)	Boiler Output Required (BTUH)	Boiler Side Minimum (GPM)
APSMO5X12-6	750	31,300	2
APSMO5X12-8	1,000	41,725	3
APSMO5X12-10	1,500	62,588	4
APSMO5X12-16	2,000	83,450	6
APSMO5X12-20	4,000	166,900	11
APSMO5X12-30	6,000	250,350	17
APSMO5X12-40	8,000	333,800	22

#### NOTES:

- Typical Design Conditions: 180°F boiler water to heat exchanger and 105°F spa water.
- Bypass/balancing valve on spa side of heat exchanger REQUIRED to allow for full spa pump flow.
- Spa side pressure drop for all models ranges from 4.0 psig or higher depending on setting of bypass/balancing valve.
- For 160°F boiler water, increase product model size by 1.5 (i.e. APSMO5x12-16 at 180°F, use APSMO5x12-24 at 160°F).
- For 200°F boiler water and steam, use the same model size and multiply minimum boiler GPM by 0.60.
- Materials Used: 254SMO stainless alloy; nickel braze; stainless steel MPT fittings and mounting studs.
- Design Working Pressure: 300 psig.
- Conversion from psig to ft-head: Multiply psig value by 2.31.

To select a APSMO series Heat Exchanger for a **Spa**:

Step 1: Determine the Capacity (Gallons) of the Spa or Hot Tub. (See Step 2 in Pool calculations)

Step 2: From the Spa selection table, based on the Spa Capacity (Gallons), select the appropriate heat exchanger and boiler capacity based on the Heat Up Rate.

**NOTE:** A spa is typically operated at 100°F-105°F, requires a faster heat up rate and, due to aeration, has a higher heat loss to surroundings. The table below is based on 3°F/hr plus heat losses due to aeration.

# AURORA 1081BP SERIES

## SELECTION TABLES

### MODEL AP – BRAZED PLATE HEAT EXCHANGERS FOR SNOW MELT APPLICATIONS

Brazed Plate heat exchangers are very cost effective in Snow Melt applications, providing high output, fast response and separation of the fluids. Used for boiler water to glycol heat transfer and, in some applications, zone isolation, the AP series provides an easy solution to Snow Melt systems.

Most Snow Melt systems are boiler water to glycol 10%-40% (typical), depending on location and weather conditions. The heat exchanger isolates the glycol from the boiler water and provides an oxygen barrier to the boiler, which protects other components in the boiler system.

To select a Heat Exchanger for a **Snow Melt** application:

Step 1: Determine the Total BTUH required (from guidance from your Radiant Tube supplier) for the Snow Melt system.

Step 2: Select the appropriate AP model from the table, based on the Total BTUH required.

If the boiler water temperature is 180°F or higher, or steam, use the Table shown. If the boiler water temperature is less than 180°F, contact your local Aurora Pump sales representative.

Step 3: Check the total GPM required. If the GPM requirement of the Snow Melt system is greater than the GPM listed in the selection table, select a larger model to match the GPM and pressure drop needs or install a bypass/balancing valve. This will allow full flow and optimum pressure drop for the pump. This applies to the GPM(s) on both boiler and glycol sides.

Example: For a snow melt system requiring a 122,000 BTUH, model AP4H-14 (3/4" MPT) would be selected from the table. If the GPM requirement is greater than 8.3, use the next largest model to match the pump requirement.

Models	Boiler: 180°F Supply, 150° Return Snow Melt: 100°F Return, 130° Supply (40% PG)					
	No. of Plates	Capacity (Btu/hr)	Side-A (Boiler) (GPM) PD (psi)		Side-B (Snow Melt) (GPM) PD (psi)	
AP4H-8	8	61,000	4.1	4.9	4.4	4.8
AP4H-10	10	82,000	5.5	4.9	5.9	5.5
AP4H-12	12	102,000	6.9	4.9	7.3	5.8
AP4H-14	14	122,000	8.3	4.9	8.8	6.1
AP4H-16	16	144,000	9.8	5.0	10.3	6.4
AP4H-20	20	185,000	12.6	5.0	13.3	6.7
AP4H-24	24	225,000	15.3	5.0	16.2	6.9
AP4H-30	30	282,000	19.2	4.9	20.3	7.0
AP4H-36	36	337,000	22.9	4.8	24.3	7.0
AP4H-40	40	372,500	25.4	4.8	26.9	7.0
AP4H-50	50	457,000	31.1	4.7	33.0	7.0
AP4H-60	60	600,000	40.9	5.8	43.3	8.5
AP4H-70	70	675,000	46.0	5.8	48.7	8.5
AP4H-80	80	800,000	54.5	6.7	57.7	9.7
AP57H-20	20	500,000	34.0	4.9	36.1	6.8
AP57H-24	24	650,000	44.3	5.5	46.9	7.9
AP57H-30	30	850,000	57.9	5.8	61.3	8.5
AP57H-36	36	1,050,000	71.6	6.0	75.8	9.0
AP57H-40	40	1,175,000	80.1	6.1	84.8	9.2
AP57H-50	50	1,525,000	103.9	6.5	110.1	10.0
AP57H-60	60	1,875,000	129.5	7.1	137.2	10.9
AP57H-70	70	2,150,000	153.4	7.5	162.4	11.5
AP57H-80	80	2,500,000	170.4	7.4	180.5	11.3
AP57H-90	90	2,750,000	187.5	7.5	198.6	11.3
AP57H-100	100	3,000,000	204.5	7.7	216.6	11.6

**NOTES:**

1. Larger models are available. Contact your local Aurora Pump sales representative.
2. For 200°F boiler water, use the same model size and multiply minimum boiler GPM by 0.60.

**Piping:** A boiler side bypass/balancing valve is recommended, but not required. A three-way tempering valve or motorized control valve on the snow melt side is required.

**Controls:** A three-way tempering valve is required to allow for adjustment of the snow melt side and to limit the temperature of the glycol. For radiant tubing in sand, maximum glycol temperature is 140°F. In asphalt and concrete, maximum temperature is typically 150°F. Recommended set point 130°F for the glycol snow melt side.

**Startup:** Adjust the three-way tempering valve to 130°F or the desired set point.

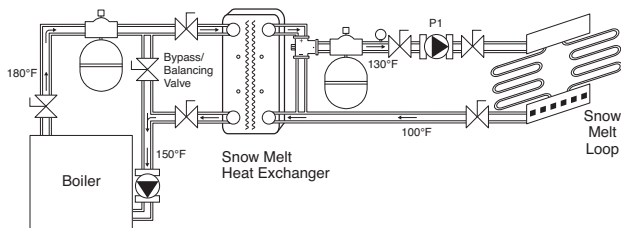



## SELECTION TABLES MODEL AP – BRAZED PLATE HEAT EXCHANGERS FOR CLOSE APPROACH

Brazed Plate heat exchangers can be used in applications whereby the Approach Temperatures can be 10°F or less and as low as 2°F, which means the heating (or cooling) source will heat (or cool) the secondary load side to within a 2°F-10°F of the source temperature. This capability allows for a variety of applications and versatility for utilizing Brazed Plate heat exchangers. Brazed Plate heat exchangers can be used for many Fluid-to-Fluid applications where a heating (or cooling) source is used to transfer heat to a load.

Applications include:

- **Boiler Water to Process**
- **Chilled Water to Process**
- **Glycol to Process Water**
- **Process Water to Process Water**
- **Hot Water Heater to Radiant Floor**
- **Cooling Tower/Free Cooling to Chilled Water loop**
- **Engine Water to Process**
- **High Pressure (300psi) Isolation to Low Pressure (150psi) Equipment**
- **Sea Water to Process (APSMO Series)**

Approach Temperature = Side A (Source) Entering Temperature (°F) minus Side B (Load) Leaving Temperature (°F)

Example:

Side A: **95°F in** , 85°F out

Side B: 77°F in , **87°F out** = 8°F Approach

Temperature Difference (TD) of (Side A or Side B) are defined as:

Entering Temperature *minus* Leaving Temperature

Example:

Side A: 95°F in , 85°F out = 10°F TD for Side A

Side B: 77°F in , 87°F out = 10°F TD for Side B

Optimum Approach Temperature for a Brazed Plate heat exchanger is typically 10°F for cost effective selections; however, 3°F and 4°F Approach Temperatures are possible for special applications.

Ideal Temperature Difference (TD) is typically 10°F and is preferred in many applications.

To select a **Close Approach Heat Exchanger**, use the Selection tables.

Step 1: Determine the BTUH Heat Transfer required.

Step 2: Select the desired Approach Temperature for your application, then consult the appropriate table.

Example: For 100,000 BTUH boiler water at 180°F, to be used to heat water to 172°F (an 8°F approach), select model AP4H-36 from the 8°F Approach table.

NOTE: The tables assume 10°F temperature split on both the boiler (180°F in/170°F out) and 10°F temperature split on the load side (162°F in/172°F out).

Step 3: Use the Temperature Correction Factor table for fluid temperatures below 80°F. Multiply the Correction Factor by the last two digits of the model number to obtain the appropriate model.

Example: If model AP4H-50 is selected and one of the fluids is entering at 55°F, multiply the last two digits of the model number by 1.21 (AP4H-50) to obtain AP4H-60 as the appropriate selection.

**Diagram 1-Standard Piping Arrangement 10°F and Higher Approach**

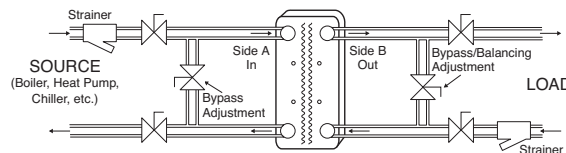

**Diagram 2-Heat Exchanger to Cooling Tower**

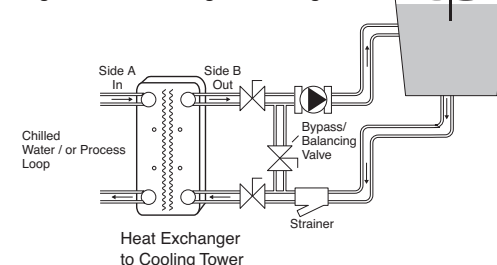

**Diagram 3-High Pressure Isolation**

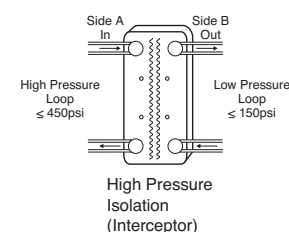

# AURORA 1081BP SERIES

## SELECTION TABLES

### MODEL AP – BRAZED PLATE HEAT EXCHANGERS FOR CLOSE APPROACH

**Approach Temperature = Hot Side Supply Temp. In (Side-A In) minus Cold Side Temp. Out (Side-B Out).**

Models	10°F Approach					8°F Approach					6°F Approach				
	Capacity	Side-A (Boiler)		Side-B (Radiant)		Capacity	Side-A (Boiler)		Side-B (Radiant)		Capacity	Side-A (Boiler)		Side-B (Radiant)	
	(Btu/hr)	(GPM)	PD (psi)	(GPM)	PD (psi)	(Btu/hr)	(GPM)	PD (psi)	(GPM)	PD (psi)	(Btu/hr)	(GPM)	PD (psi)	(GPM)	PD (psi)
AP4H-8	19,888	4.0	4.5	4.0	2.7	17,402	3.5	3.5	3.5	2.0	8,452	1.7	0.9	1.7	0.5
AP4H-10	29,833	6.0	5.7	6.0	3.8	24,363	4.9	3.8	4.9	2.5	11,933	2.4	1.0	2.4	0.6
AP4H-12	39,777	8.0	6.4	8.0	4.6	30,827	6.2	3.9	6.2	2.8	14,916	3.0	1.0	3.0	0.7
AP4H-14	44,749	9.0	5.7	9.0	4.3	38,285	7.7	4.2	7.7	3.2	18,397	3.7	1.0	3.7	1.0
AP4H-16	54,694	11.0	6.2	11.0	4.9	44,749	9.0	4.2	9.0	3.3	22,374	4.5	1.1	4.5	0.9
AP4H-20	74,582	15.0	7.0	15.0	5.8	57,180	11.5	4.2	11.5	3.5	28,838	5.8	1.1	5.8	0.9
AP4H-24	89,499	18.0	6.8	18.0	5.9	69,610	14.0	4.2	14.0	3.6	36,297	7.3	1.2	7.3	1.0
AP4H-30	113,863	23.0	6.9	23.0	6.2	84,527	17.0	3.9	17.0	3.5	46,241	9.3	1.2	9.3	1.1
AP4H-36	138,227	28.0	7.1	28.0	6.5	104,416	21.0	4.1	21.0	3.8	57,180	11.5	1.3	11.5	1.2
AP4H-40	154,138	31.0	7.2	31.0	6.6	119,332	24.0	4.4	24.0	4.1	64,638	13.0	1.3	13.0	1.2
AP4H-50	193,915	39.0	7.5	39.0	7.1	149,165	30.0	4.5	30.0	4.3	79,555	16.0	1.3	16.0	1.3
AP4H-60	233,693	47.0	7.9	47.0	7.5	183,971	37.0	5.0	37.0	4.8	99,443	20.0	1.5	20.0	1.4
AP4H-70	273,470	55.0	8.4	55.0	8.1	213,804	43.0	5.2	43.0	5.0	114,360	23.0	1.5	23.0	1.5
AP4H-80	313,248	63.0	8.9	63.0	8.7	248,609	50.0	5.7	50.0	5.6	129,277	26.0	1.6	26.0	1.6

Models	6°F Approach					4°F Approach					3°F Approach				
	Capacity	Side-A (Boiler)		Side-B (Radiant)		Capacity	Side-A (Boiler)		Side-B (Radiant)		Capacity	Side-A (Boiler)		Side-B (Radiant)	
	(Btu/hr)	(GPM)	PD (psi)	(GPM)	PD (psi)	(Btu/hr)	(GPM)	PD (psi)	(GPM)	PD (psi)	(Btu/hr)	(GPM)	PD (psi)	(GPM)	PD (psi)
AP57H-20	139,221	28.0	9.6	28.0	7.9	79,555	16.0	3.3	16.0	2.7	42,263	8.5	1.0	8.5	0.8
AP57H-24	169,054	34.0	9.5	34.0	8.1	99,443	20.0	3.5	20.0	2.9	52,208	10.5	1.0	10.5	0.8
AP57H-30	218,776	44.0	9.9	44.0	9.9	134,249	27.0	3.9	27.0	3.4	69,610	14.0	1.1	14.0	1.0
AP57H-36	263,526	53.0	9.8	53.0	8.8	164,082	33.0	4.0	33.0	3.6	84,527	17.0	1.1	17.0	1.0
AP57H-40	293,359	59.0	9.7	59.0	8.9	179,000	36.0	3.8	36.0	3.5	94,471	19.0	1.1	19.0	1.0
AP57H-50	372,914	75.0	10.0	75.0	9.3	228,721	46.0	3.9	46.0	3.7	119,332	24.0	1.1	24.0	1.0
AP57H-60	442,525	89.0	9.8	89.0	9.3	273,470	55.0	3.9	55.0	3.7	144,193	29.0	1.1	29.0	1.1
AP57H-70	517,108	104.0	10.0	104.0	9.5	323,192	65.0	4.1	65.0	3.9	174,026	35.0	1.2	35.0	1.2
AP57H-80	586,719	118.0	10.0	118.0	9.6	372,914	75.0	4.2	75.0	4.0	198,887	40.0	1.2	40.0	1.2
AP57H-90	651,358	131.0	9.9	131.0	9.6	422,636	85.0	4.3	85.0	4.2	223,748	45.0	1.3	45.0	1.2
AP57H-100	715,996	144.0	10.0	144.0	9.7	472,358	95.0	4.5	95.0	4.4	248,609	50.0	1.3	50.0	1.3
AP57H-110	775,663	156.0	9.9	156.0	9.7	522,080	105.0	4.6	105.0	4.5	273,470	55.0	1.3	55.0	1.3
AP57H-120	835,329	168.0	10.0	168.0	9.8	571,802	115.0	4.8	115.0	4.7	298,331	60.0	1.4	60.0	1.3
AP57H-130	890,023	179.0	9.9	179.0	9.8	621,524	125.0	5.0	125.0	4.9	323,192	65.0	1.4	65.0	1.4
AP57H-140	944,717	190.0	10.0	190.0	9.8	671,246	135.0	5.2	135.0	5.1	348,053	70.0	1.4	70.0	1.4
AP57H-150	994,439	200.0	10.0	200.0	9.8	720,968	145.0	5.4	145.0	5.3	372,914	75.0	1.5	75.0	1.5
AP57H-160	1,039,189	209.0	9.9	209.0	9.8	770,690	155.0	5.6	155.0	5.5	397,775	80.0	1.5	80.0	1.5
AP57H-170	1,083,939	218.0	10.0	218.0	9.8	820,412	165.0	5.8	165.0	5.7	422,636	85.0	1.6	85.0	1.6
AP57H-180	1,128,689	227.0	10.0	227.0	9.9	870,134	175.0	6.0	175.0	6.0	447,497	90.0	1.6	90.0	1.6
AP57H-190	1,163,494	234.0	9.9	234.0	9.8	919,856	185.0	6.3	185.0	6.2	472,358	95.0	1.7	95.0	1.7
AP57H-200	1,203,272	242.0	10.0	242.0	9.9	969,578	195.0	6.6	195.0	6.5	497,219	100.0	1.8	100.0	1.8

**NOTES:**

1. All the tables shown assume a 10°F Split in the IN/OUT temperatures of both Side A and Side B fluids. Identical GPM, both sides. For temperature splits other than a 10°F TD Split or if Glycols are being used, call your local Aurora Pump sales representative for a computer selection.
2. For applications with brackish, pool, spa and low PH water or steam, substitute APSMO5x12 models. See page 309 for the correct model number and fluid compatibility.
3. For 2°F Approach Temperatures, use the 4°F table for Btu/hr and GPM selection to select two identical models to be piped in series. Fluid pressure drop will be twice that shown.
4. For 10°F Approach Temperatures or greater, contact your local Aurora Pump sales representative for exact selection.

Fluid Entering Temperature	Model Correction Factor
> 80°F	1.00
> 60°F and < 80°F	1.21
> 32°F and < 60°F	1.42

**NOTES:**

1. Multiply the last two digits of the model number to obtain the correct model.
2. For glycol applications, contact your local Aurora Pump sales representative.

## SELECTION TABLES

### MODEL AP – BRAZED PLATE HEAT EXCHANGERS

### FOR REPLACEMENT HEAT EXCHANGERS

There are two simple ways to select a Brazed Plate Heat Exchanger to replace a Shell & Tube Heat Exchanger. Both methods provide exact or improved performance selection.

#### Method A. Heat Transfer Surface Method

This method uses a near exact way of matching the heat transfer surface area of the heat exchanger, which defines the nominal performance of the unit. Because Brazed Plate units perform 20%-80% better than Shell & Tube Heat Exchangers on a heat transfer surface basis, a 20%-80% safety factor is embedded in this method. This approach works for almost any type of fluid-to-fluid and steam-to-fluid heat exchangers.

Step 1: Count the number of tubes in the Shell & Tube Heat Exchanger. **# of tubes = \_\_\_\_\_**

Step 2: Measure the external diameter of the tube(s).

**OD Diameter of bare tube is:**

**(.25", .375", .5", .625", .75", .875" or \_\_\_\_\_).**

If the tubes have fins or protrusions, call your Aurora Pump sales representative.

Step 3: Measure the length of the tube(s) from end sheet to end sheet. **Length of tubes = \_\_\_\_\_ inches.**

If U-tube bundle, use overall length of U-tube bundle.

Step 4: Multiply:

#Tubes \_\_\_\_\_ x Diameter of tube \_\_\_\_\_ (inches) x **3.14** x Tube Length \_\_\_\_\_ (inches) x **.0069** (ft<sup>2</sup>/in<sup>2</sup>) x **1.2 Safety factor** = \_\_\_\_\_ **Sq. Feet of Heat Transfer Surface**

Step 5: Select the corresponding Brazed Plate model based on the Sq. Feet column above.

Step 6: Installation – The fluid pressure drop of the new installation must closely match (+/- 20%) that of the former Shell & Tube installation so that the pump performance and fluid flow remain the same. Make sure bypass/balancing valves are installed on all fluid circuits to the heat exchanger (boiler and secondary side while excluding steam lines). Adjust for proper pressure drop across the heat exchanger, which should match the pressure drop across the (former) Shell & Tube heat exchanger.

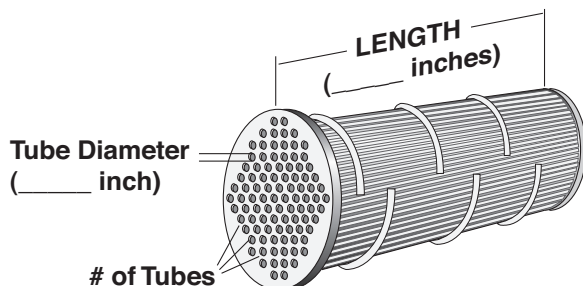

Hydronic Models (AP4H)	Sq Feet Surface
AP4H-8	2.3
AP4H-10	3.1
AP4H-12	3.8
AP4H-14	4.6
AP4H-16	5.4
AP4H-20	6.9
AP4H-24	8.4
AP4H-30	10.7
AP4H-36	13.0
AP4H-40	14.6
AP4H-50	18.4
AP4H-60	22.2
AP4H-70	26.1
AP4H-80	29.9

Hydronic Models (AP57H)	Sq Feet Surface
AP57H-20	23.6
AP57H-24	28.9
AP57H-30	36.8
AP57H-40	49.9
AP57H-50	63.0
AP57H-60	76.1
AP57H-70	89.3
AP57H-80	102.4
AP57H-90	115.5
AP57H-100	128.6
AP57H-110	141.8
AP57H-120	154.9
AP57H-130	168.0
AP57H-140	181.1
AP57H-150	194.3
AP57H-160	207.4
AP57H-170	220.5
AP57H-180	233.6
AP57H-190	246.8
AP57H-200	259.9

**NOTE:**  
For Steam, CuNi-Cupronickel and Brass Shell & Tube Replacements, or Swimming Pool water and installations with questionable water quality, substitute Aurora Pump APSMO series for the AP model number.

#### Method B. Design Condition Method

The standard design and selection method of a heat exchanger is based on "Design Conditions." This heat exchanger can either be selected from one of the SELECTION charts in this catalog or computer selected. The following information is required for a computer selection:

##### Hot Side A

Fluid \_\_\_\_\_ (Water, or, %Glycol, or Fluid Type)  
 Temperature IN \_\_\_\_\_ °F (or °C)  
 Temperature OUT \_\_\_\_\_ °F (or °C)  
 Flow Rate \_\_\_\_\_ GPM (or L/min)  
 Fouling Factor (.0001 standard)  
 Maximum allowable Pressure drop \_\_\_\_\_ psig

##### Cold Side B

Fluid \_\_\_\_\_ (Water, or, %Glycol, or Fluid Type)  
 Temperature IN \_\_\_\_\_ °F (or °C)  
 Temperature OUT \_\_\_\_\_ °F (or °C)  
 Flow Rate \_\_\_\_\_ GPM (or L/min)  
 Fouling Factor (.0001 standard)  
 Maximum allowable Pressure drop \_\_\_\_\_ psig

**Total Heat Transfer** \_\_\_\_\_ BTUH (or KW)

**NOTE:**

The Brazed Plate unit will be 1/2 to 1/5 the size and weight of the Shell & Tube heat exchanger while still offering the same performance and design conditions.

# AURORA 1081BP SERIES

## SELECTION TABLES

### MODEL AP – BRAZED PLATE HEAT EXCHANGERS

#### ACCESSORIES

#### MOUNTING BRACKETS:

Mounting of any Brazed Plate unit can be accomplished by:

1. Using a bar across the face of the unit
2. Mounting to a steel strut
3. Using a mounting bracket. Mounting brackets are designed for easy use where applicable. BKT and FR models are all stainless steel.

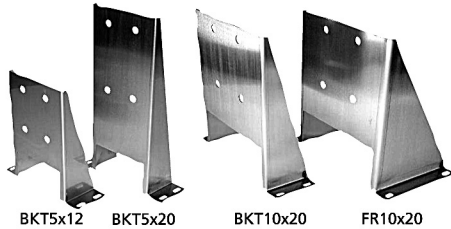

Bracket Model	Type
BKT5x12	Mounting Bracket for AP4H, APDW4, APSMO5x12
BKT5x20	Mounting Bracket for AP57H, APDW5, APSMO5x20
BKT10x20	Mounting Bracket for AP10H, APDW10, APSMO10x20
FR10x20	Rugged Floor Mounting Frame for AP57H, APDW5, APSMO5x20, 90-200 plates

PART #	BKT10x20	FR10x20	BKT5x20	BKT5x12
PLATE COUNT	10-100 PL	110-220 PL	ALL	ALL
A			5.500	3.500
B			13.625	8.625
C			14.875	9.750
D	3.000	7.000		
E	4.000	8.000		
MATL. TH'K	14 GA	10 GA	14 GA	14 GA

MATERIAL: SA-240, 304 SS

#### "Y" STRAINERS:



A water strainer is required for proper protection of the Brazed Plate fluid side for chillers, condensers and fluid-to-fluid units. These strainers are cast bronze, female pipe thread connections and rated for 400 psi working pressure at 150°F.

Model	Female Pipe Connection	Mesh Strainer	GPM at 1 psi PD	GPM at 2 psi PD
STR3/4	3/4" FPT	20 mesh	18	26
STR1	1" FPT	20 mesh	28	40
STR1-1/4	1-1/4" FPT	20 mesh	42	60
STR1-1/2	1-1/2" FPT	20 mesh	70	100
STR2	2" FPT	20 mesh	110	140
STR2-1/2	2-1/2" FPT	20 mesh	140	190
STR3	3" FPT	20 mesh	180	260
STR4	4" FPT	20 mesh	300	420

#### NOTE:

Please contact Aurora Applications Engineering (NA\_applications@pentair.com) for higher working pressure models or stainless steel versions.

#### ZINC ANODE:



A zinc anode is required for all APSMO models used in swimming pools with electronic chlorinators and for ALL applications where galvanic corrosion is possible. A zinc anode is not provided with APSMO fluid-to-fluid models.

Model	Female Pipe Connection
ANODE 3/8	3/8" FPT

**BKT & FR10x20**

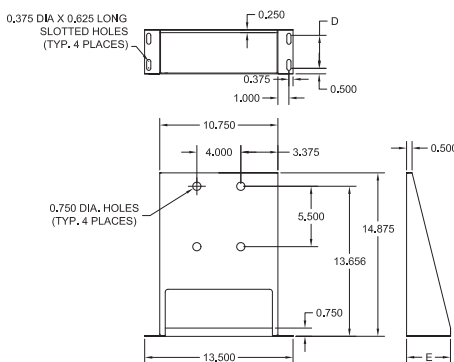

**BKT5x12 & BKT5x20**

