

2 x 2-1/2 x 9 SERIES 410

ENCLOSED IMPELLER

SIZE : 2x2-1/2x9 TYPE : 410 IMPELLER : Enclosed R. P. M. : 3550

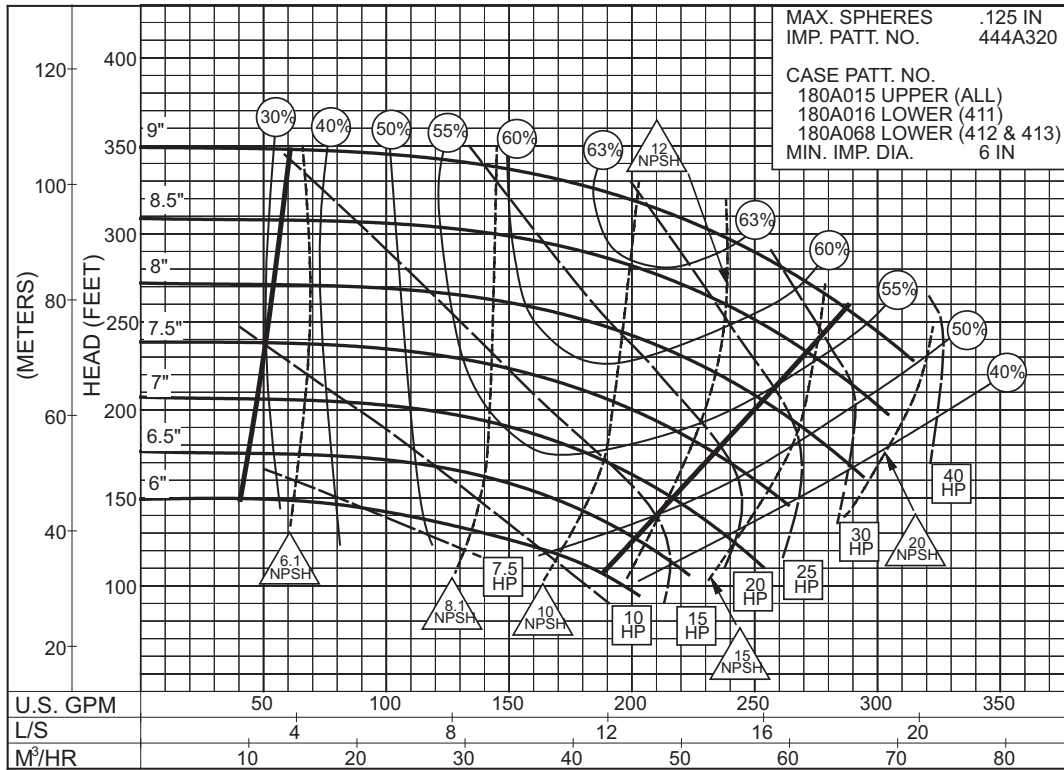

2PC-117351A

3550
RPM

SIZE : 2x2-1/2x9 TYPE : 410 IMPELLER : Enclosed R. P. M. : 1775

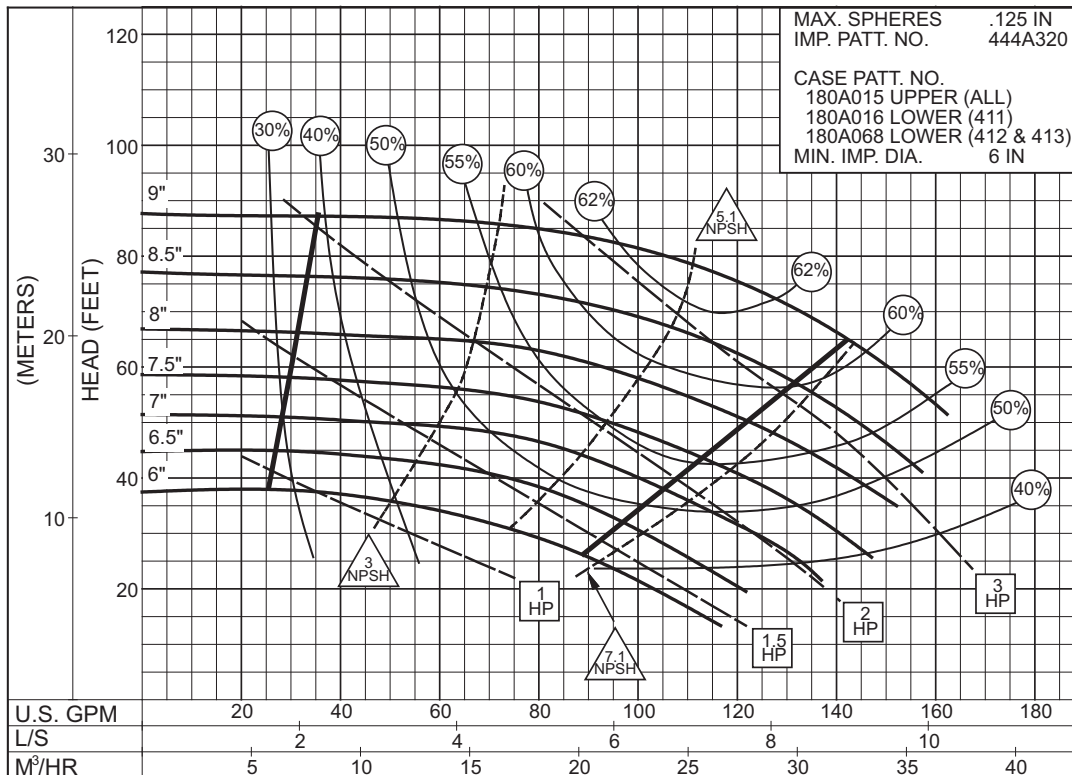

2PC-117352A

1775
RPM

2 x 2-1/2 x 10
SERIES 410

ENCLOSED IMPELLER

SIZE : 2X2-1/2X10 TYPE : 410 IMPELLER : Enclosed R. P. M. : 3550

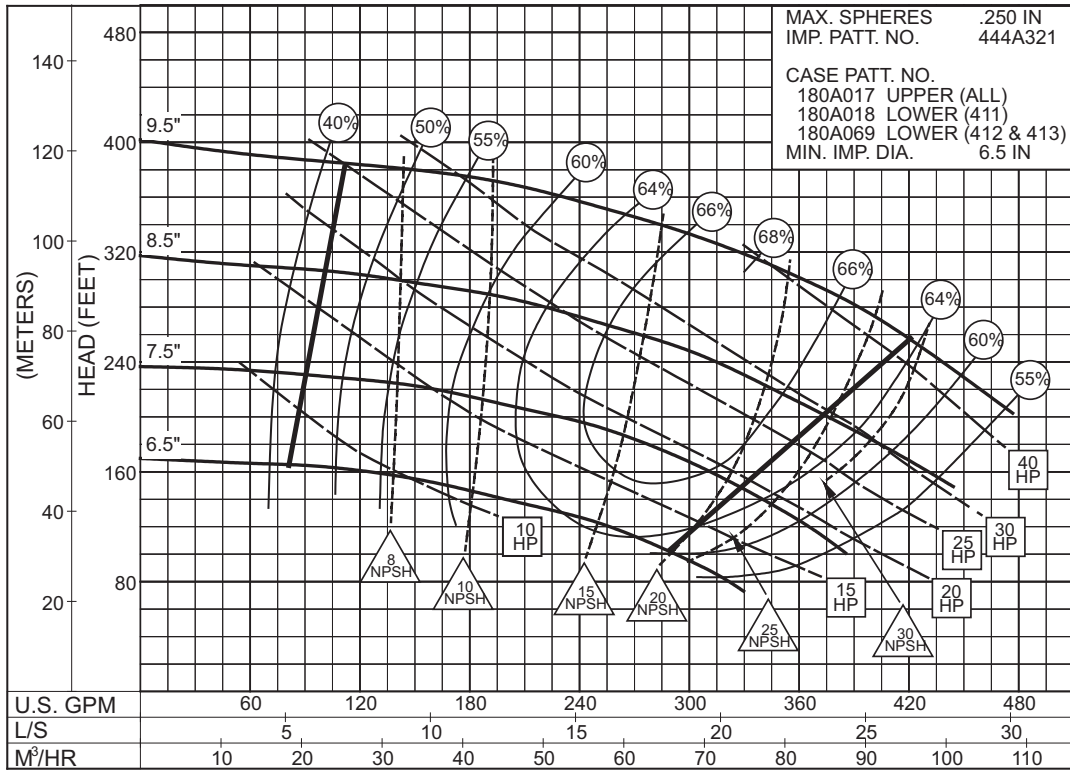

2PC-117353B

3550
RPM

SIZE : 2X2-1/2X10 TYPE : 410 IMPELLER : Enclosed R. P. M. : 1775

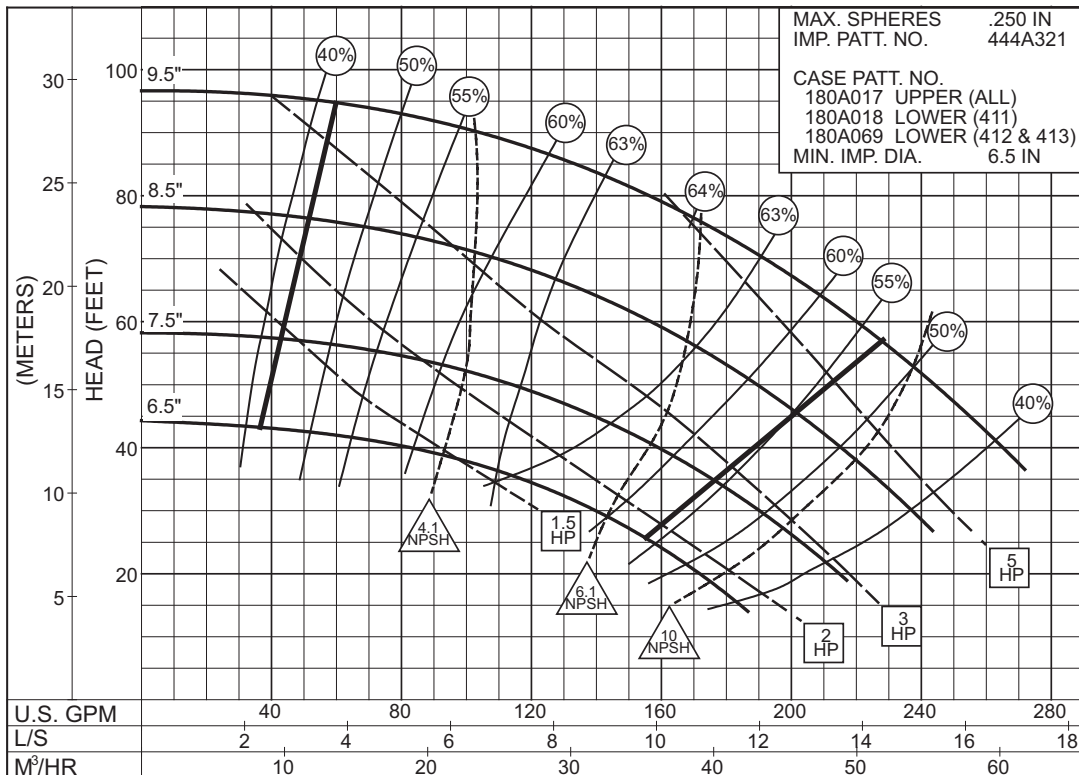

2PC-117354B

1775
RPM

2 x 2-1/2 x 12
SERIES 410

ENCLOSED IMPELLER

SIZE : 2x2-1/2x12 TYPE : 410 IMPELLER : Enclosed R. P. M. : 1775

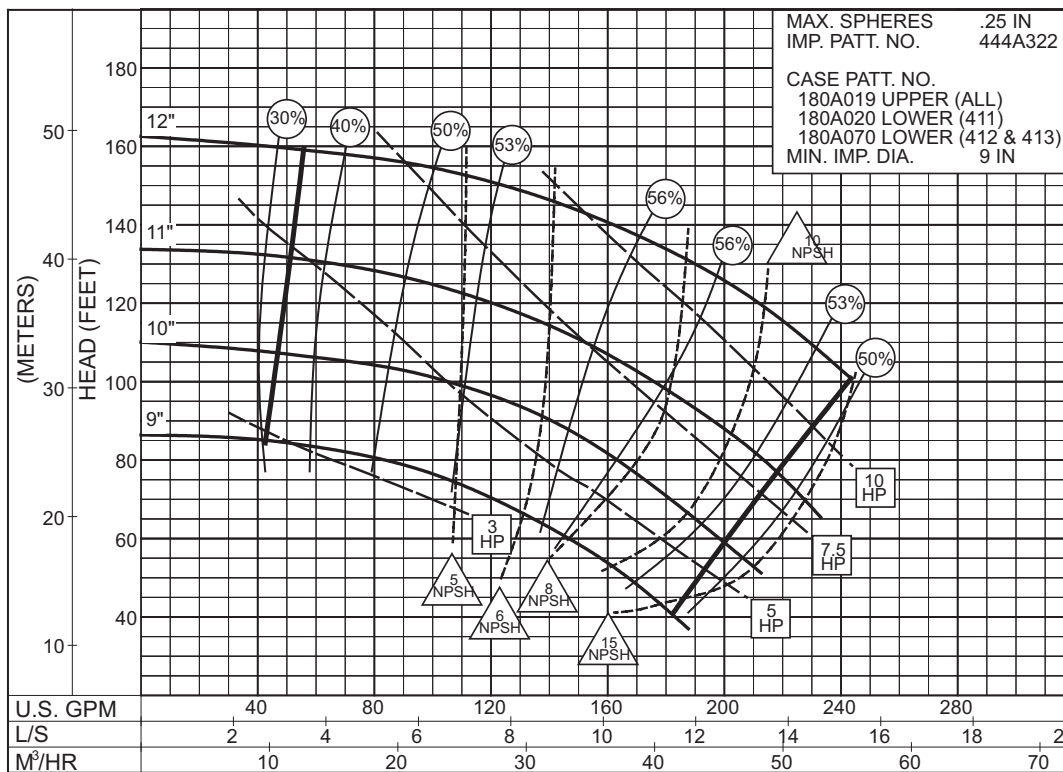

2PC-117355A

1775
RPM

SIZE : 2x2-1/2x12 TYPE : 410 IMPELLER : Enclosed R. P. M. : 1180

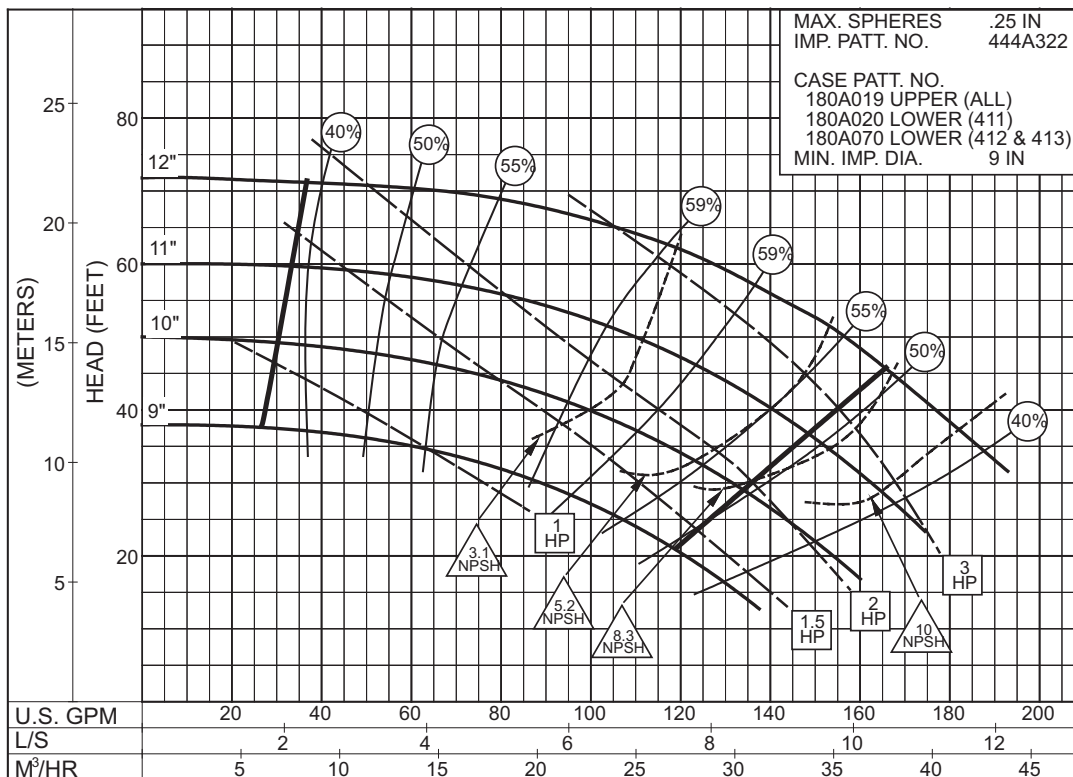

2PC-117356A

1180
RPM

2-1/2 x 3 x 10B

SERIES 410

ENCLOSED IMPELLER

SIZE : 2-1/2x3x10B TYPE : 410 IMPELLER : Enclosed R. P. M. : 3550

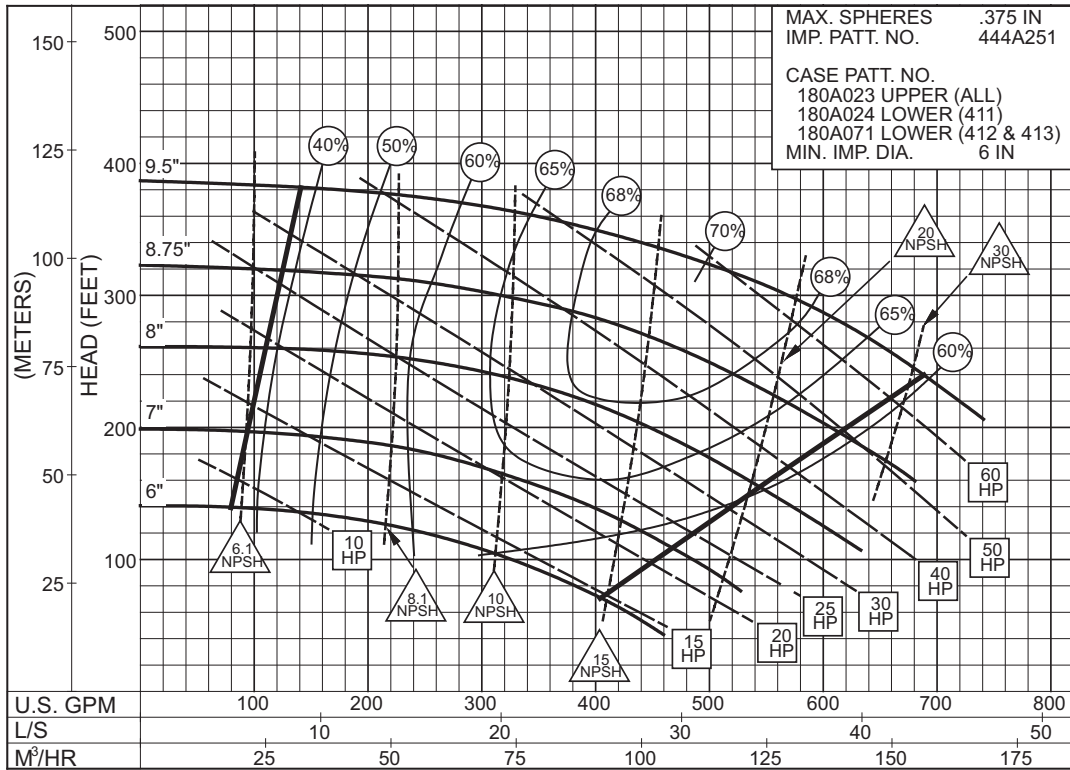

2PC-117357B

3550
RPM

SIZE : 2-1/2x3x10B TYPE : 410 IMPELLER : Enclosed R. P. M. : 1775

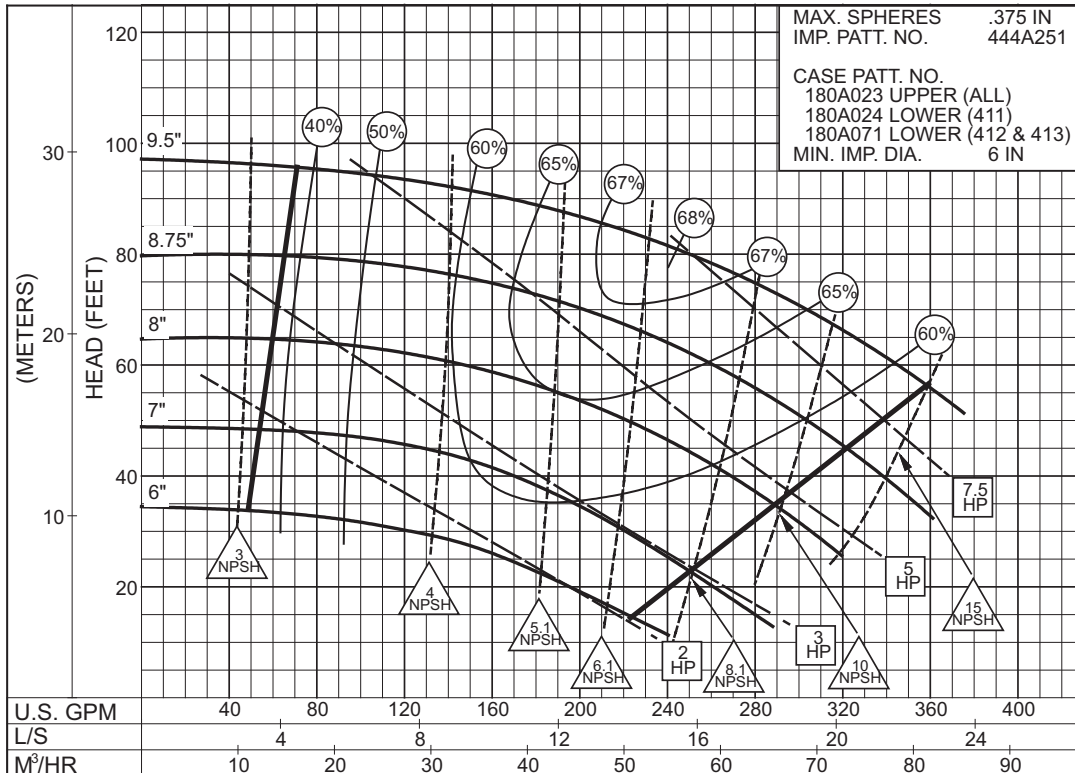

2PC-117358B

1775
RPM

2-1/2 x 3 x 12 SERIES 410

ENCLOSED IMPELLER

SIZE : 2-1/2x3x12 TYPE : 410 IMPELLER : Enclosed R. P. M. : 1775

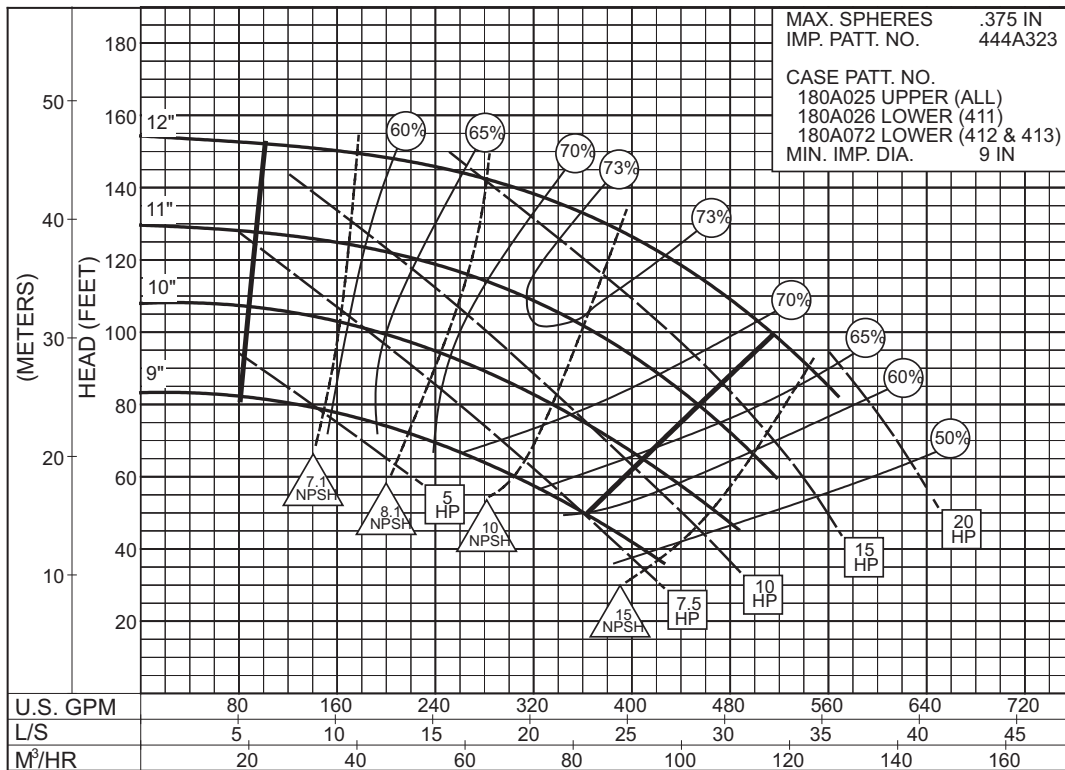

2PC-117359A

1775
RPM

SIZE : 2-1/2x3x12 TYPE : 410 IMPELLER : Enclosed R. P. M. : 1180

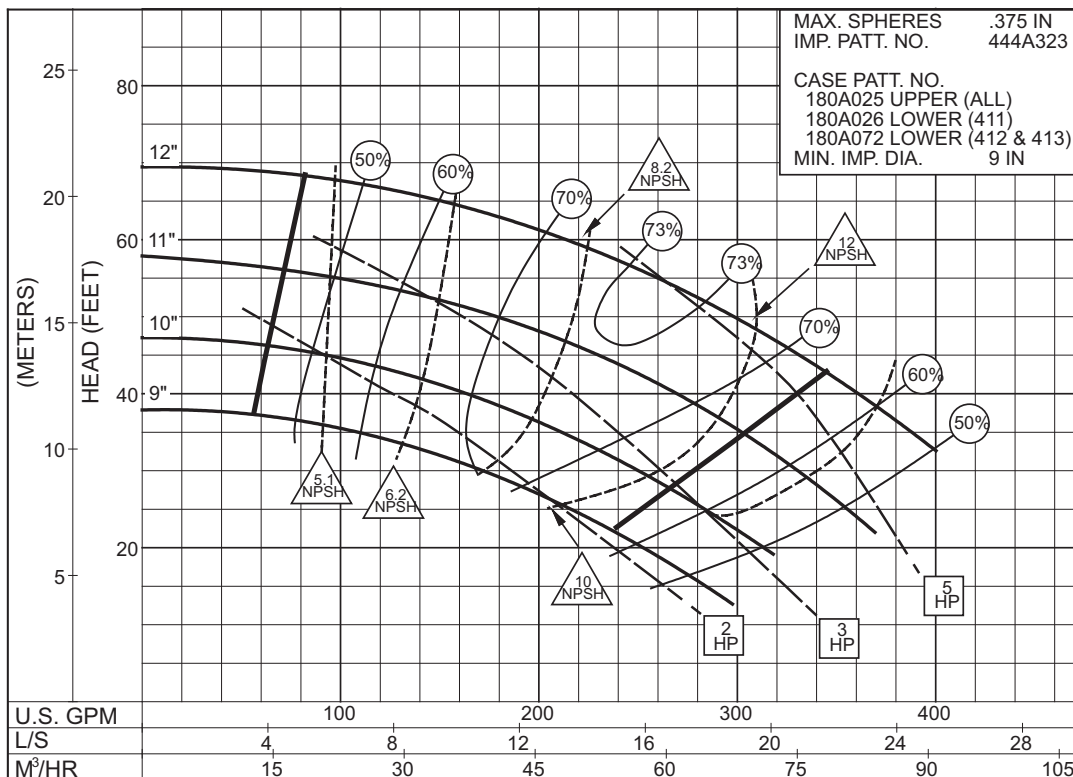

2PC-117360A

1180
RPM

3 x 4 x 10B SERIES 410

ENCLOSED IMPELLER

SIZE : 3x4x10B TYPE : 410 IMPELLER : Enclosed R. P. M. : 3550

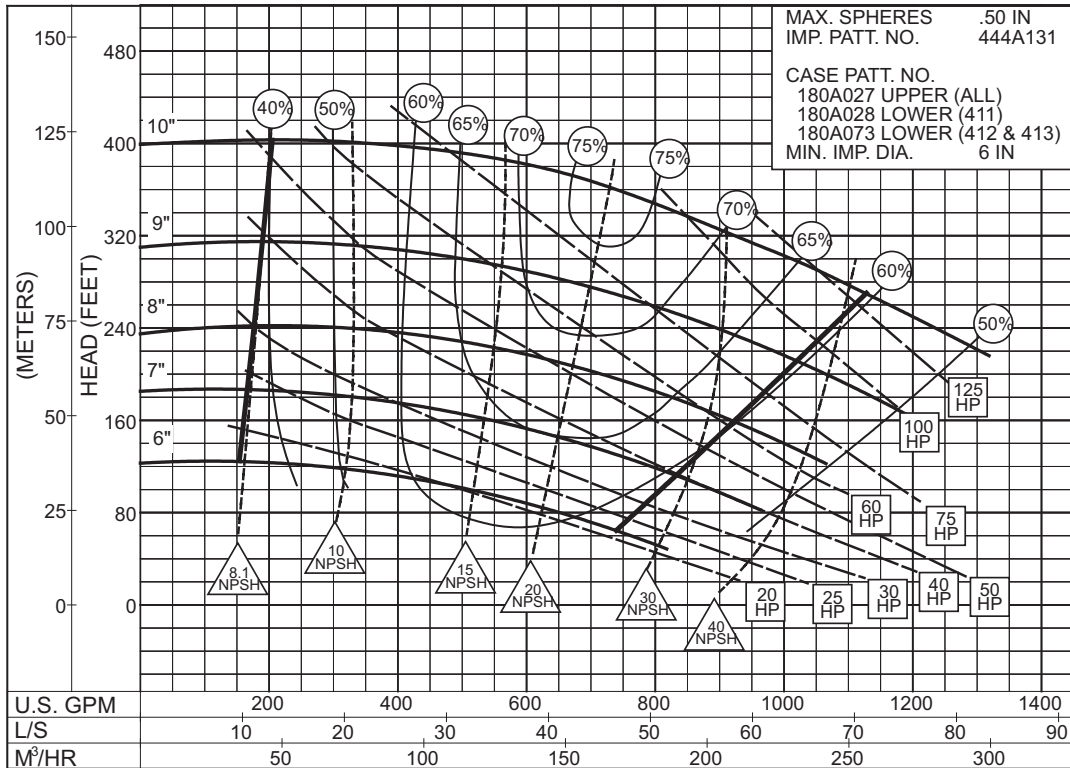

2PC-124752A

3550
RPM

SIZE : 3x4x10B TYPE : 410 IMPELLER : Enclosed R. P. M. : 1775

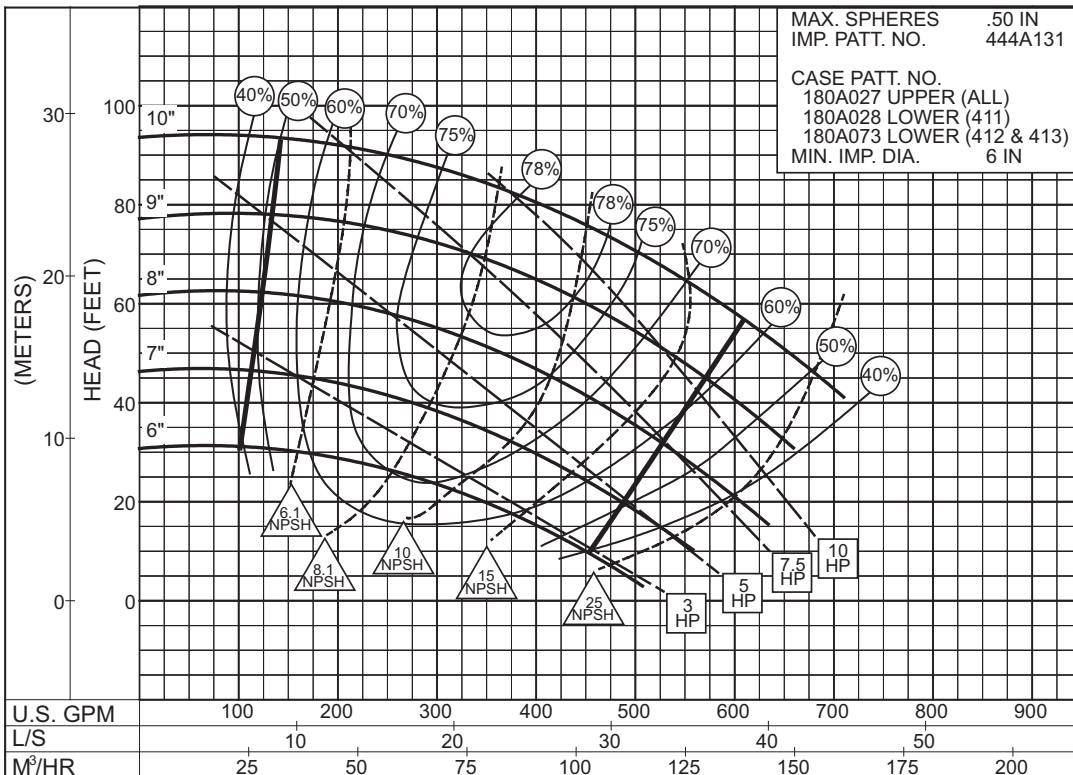

2PC-124760A

1775
RPM

3 x 4 x 10C SERIES 410

ENCLOSED IMPELLER

SIZE : 3x4x10C TYPE : 410 IMPELLER : Enclosed R. P. M. : 3550

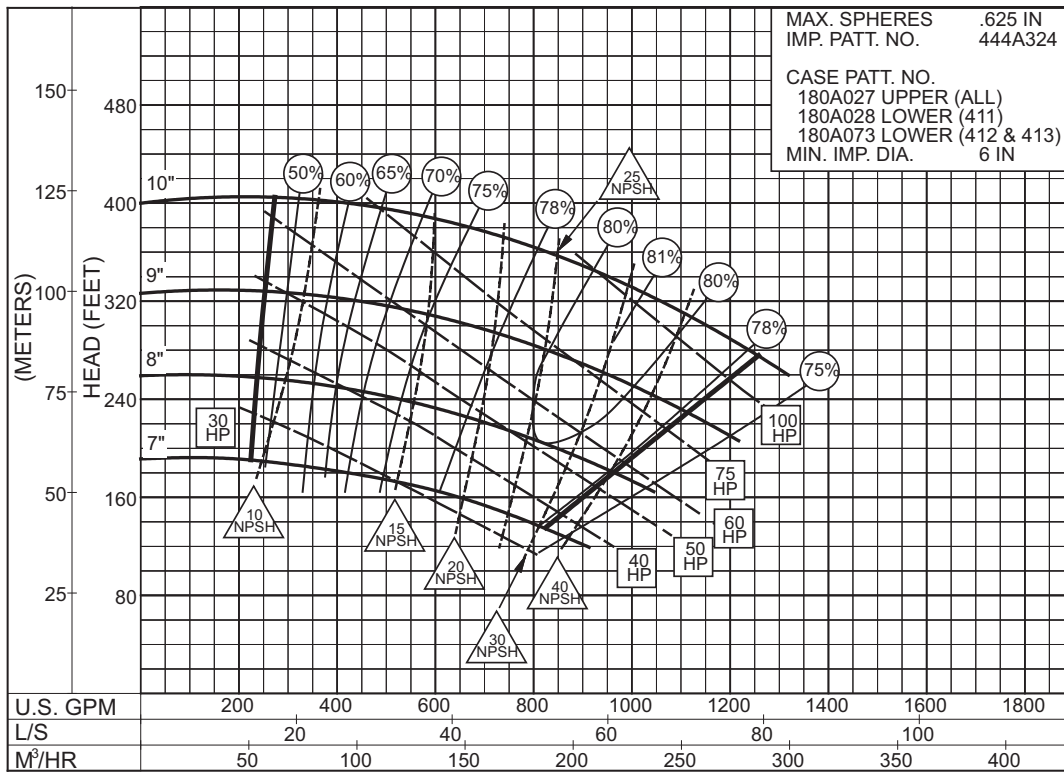

2PC-146727A

3550
RPM

SIZE : 3x4x10C TYPE : 410 IMPELLER : Enclosed R. P. M. : 1775

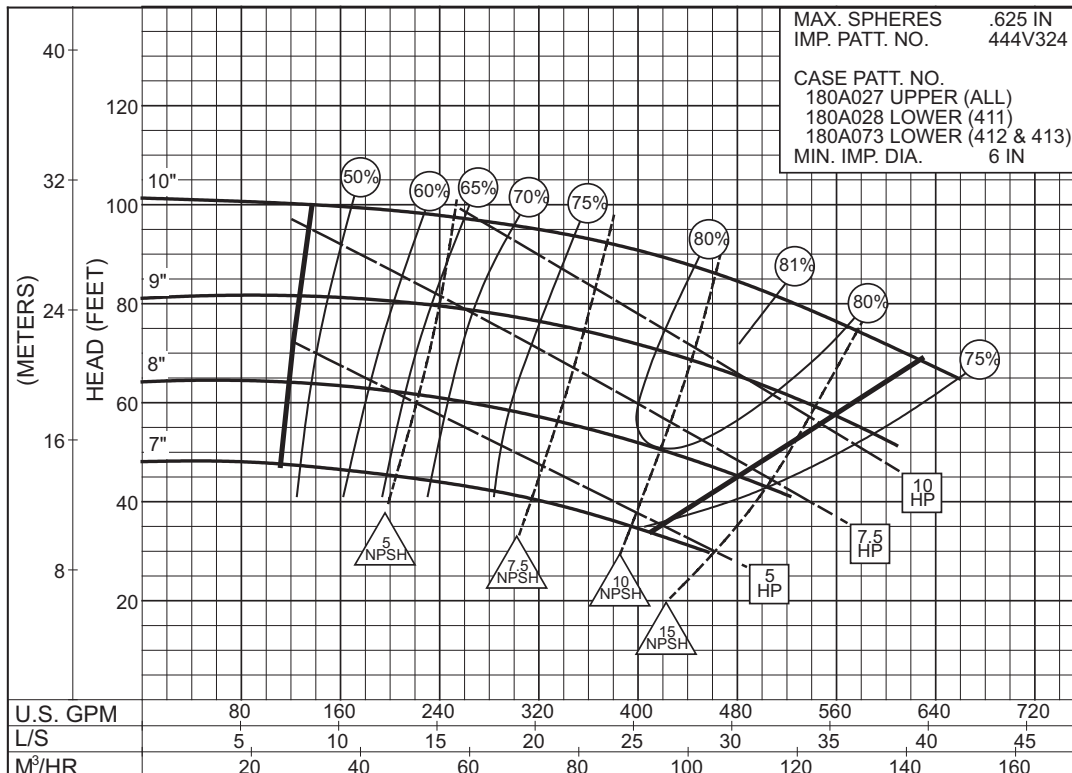

2PC-146728A

1750
RPM

3 x 4 x 14
SERIES 410

ENCLOSED IMPELLER

SIZE : 3x4x14 TYPE : 410 IMPELLER : Enclosed R. P. M. : 1775

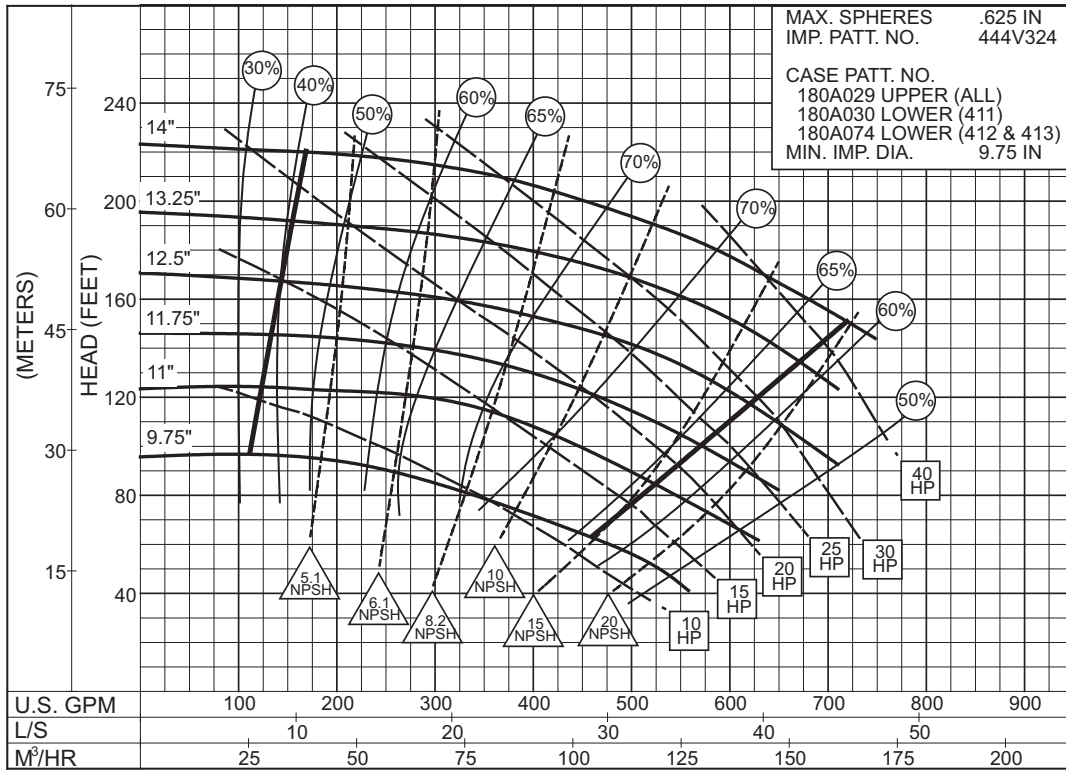

2PC-117363A

1775
RPM

SIZE : 3x4x14 TYPE : 410 IMPELLER : Enclosed R. P. M. : 1180

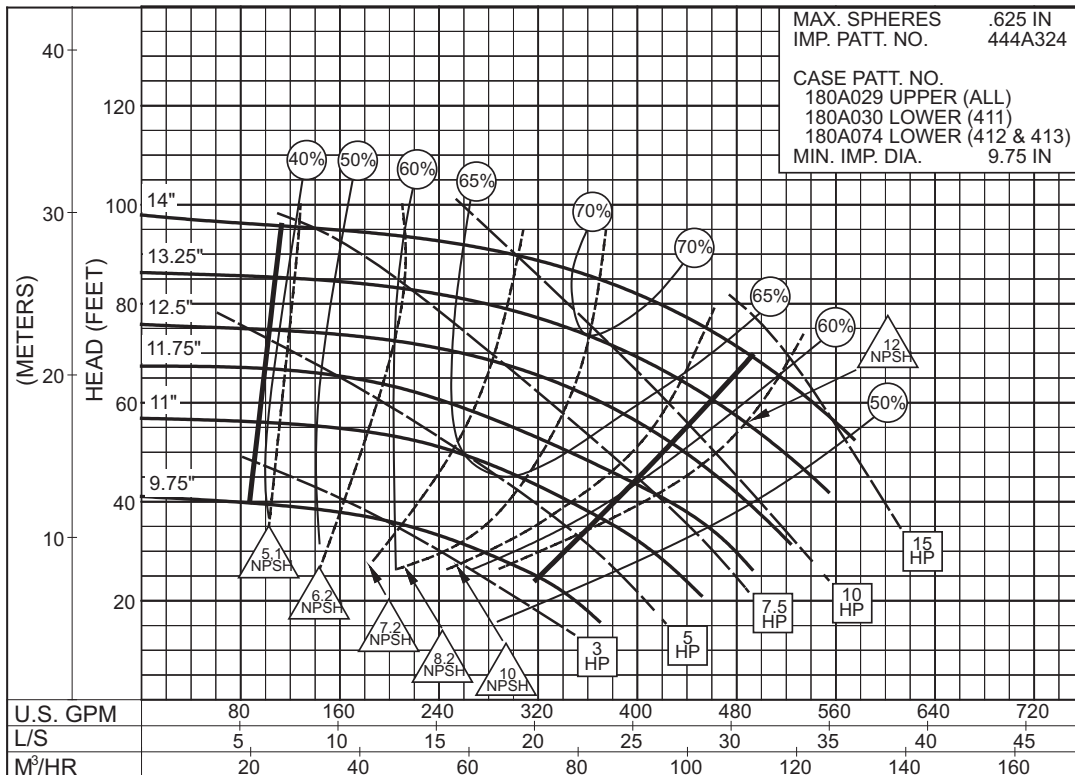

2PC-117364A

1180
RPM

4 x 5 x 10B SERIES 410

ENCLOSED IMPELLER

SIZE : 4x5x10B TYPE : 410 IMPELLER : Enclosed R. P. M. : 3550

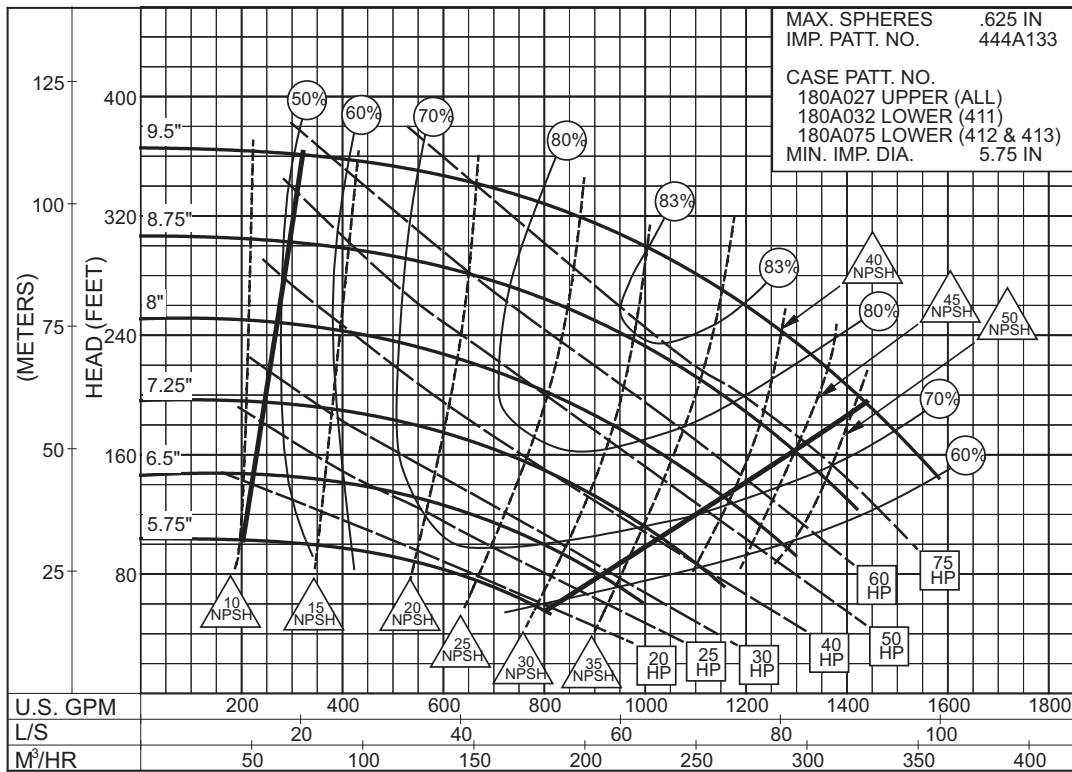

2PC-117367A

3550
RPM

SIZE : 4x5x10B TYPE : 410 IMPELLER : Enclosed R. P. M. : 1775

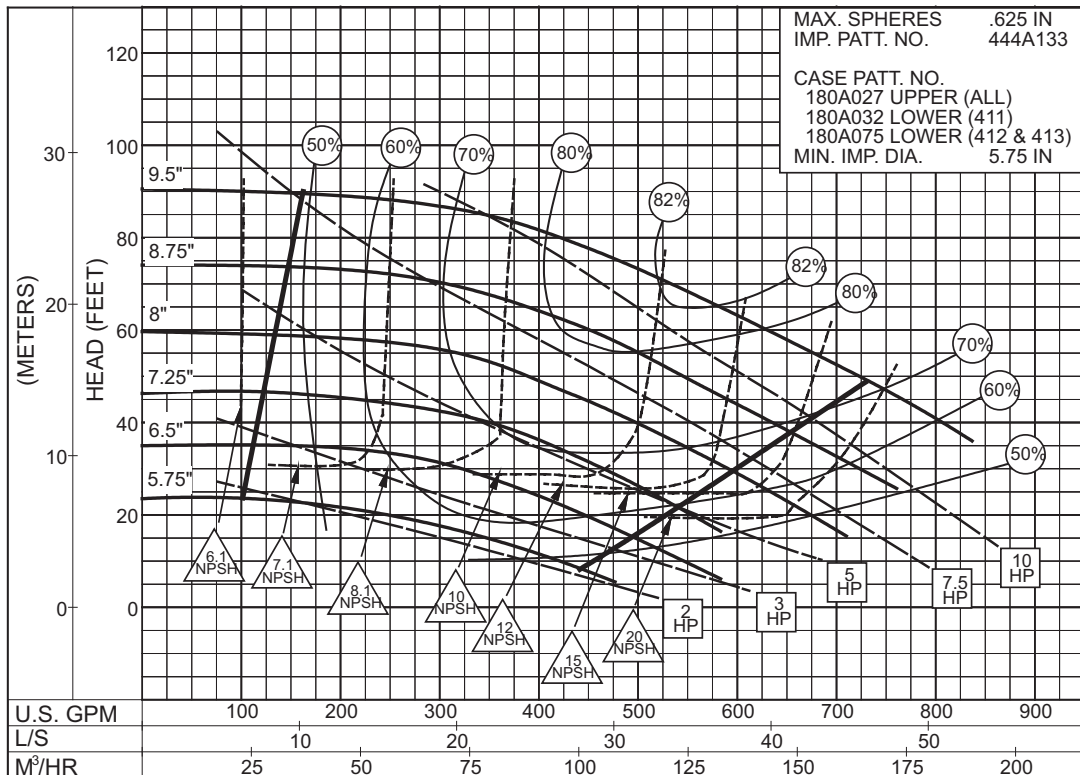

2PC-117368A

1775
RPM

4 x 5 x 11A SERIES 410

ENCLOSED IMPELLER

SIZE : 4x5x11A TYPE : 410 IMPELLER : Enclosed R. P. M. : 1775

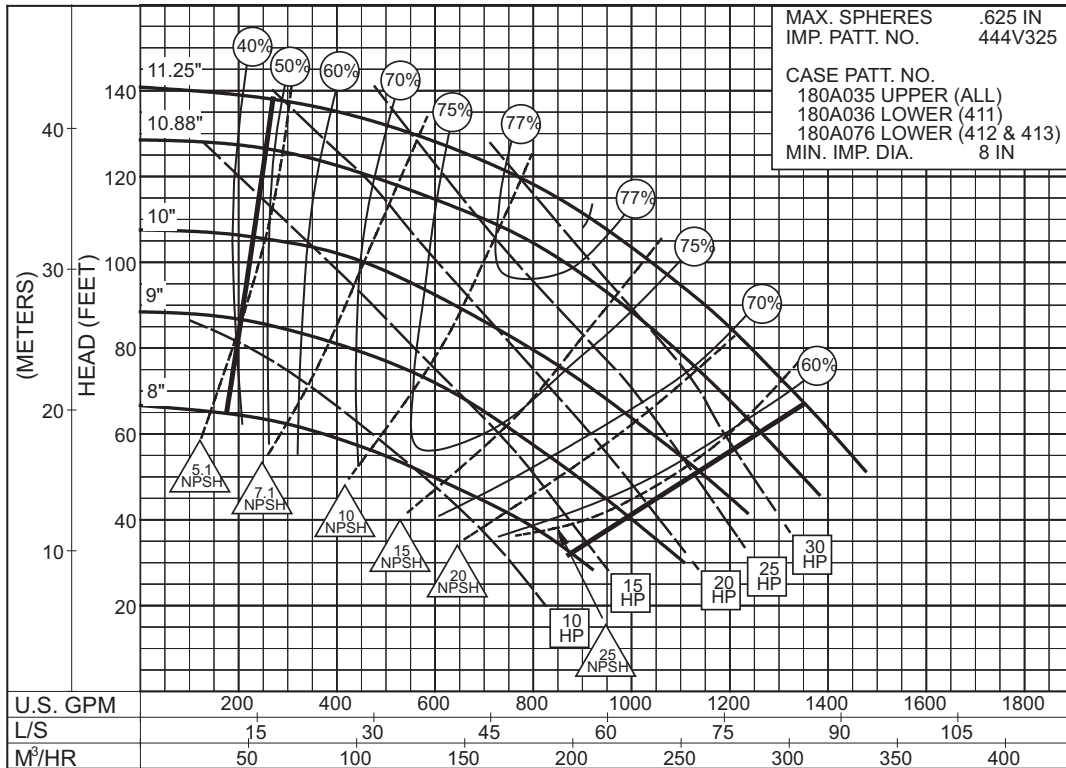

2PC-117369A

1775
RPM

SIZE : 4x5x11A TYPE : 410 IMPELLER : Enclosed R. P. M. : 1180

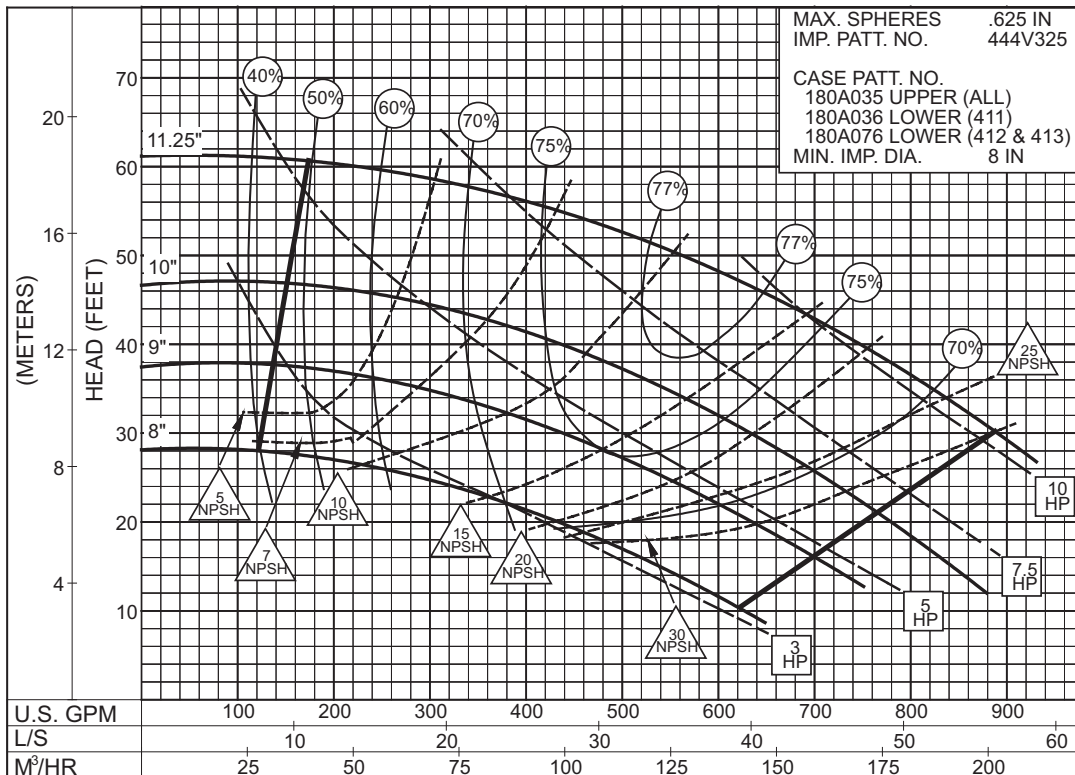

2PC-117370A

1180
RPM

4 x 5 x 11C SERIES 410

ENCLOSED IMPELLER

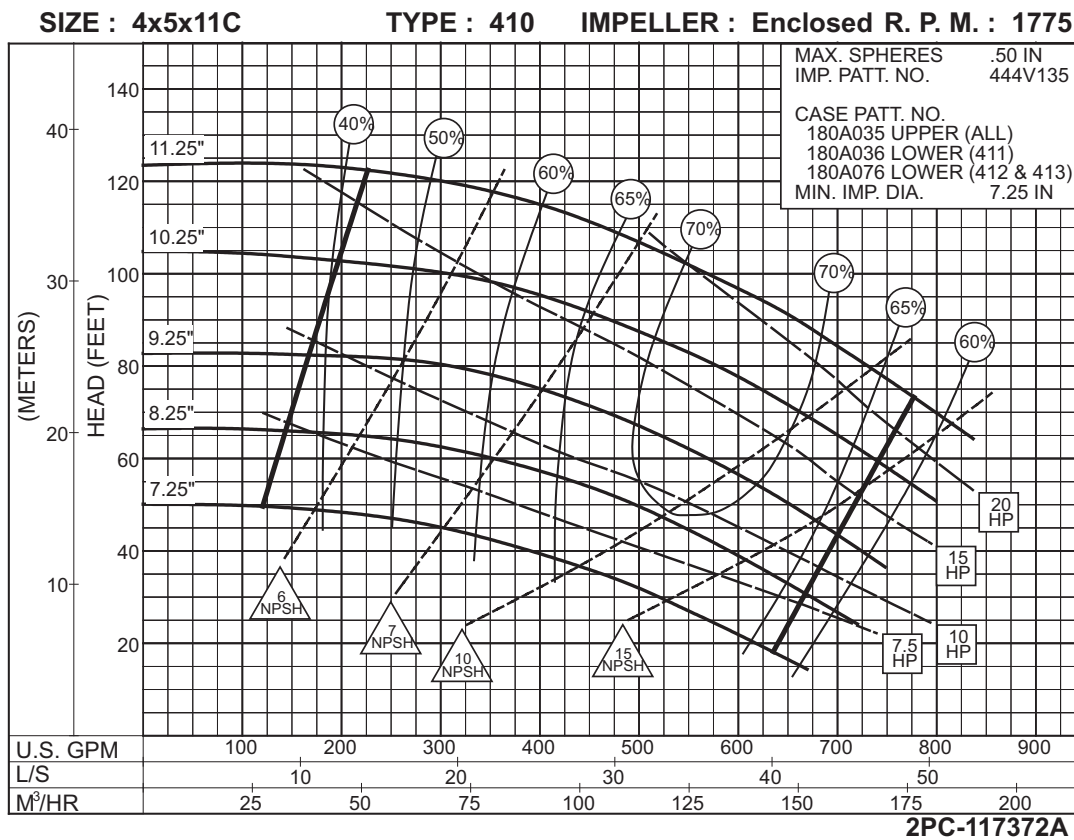
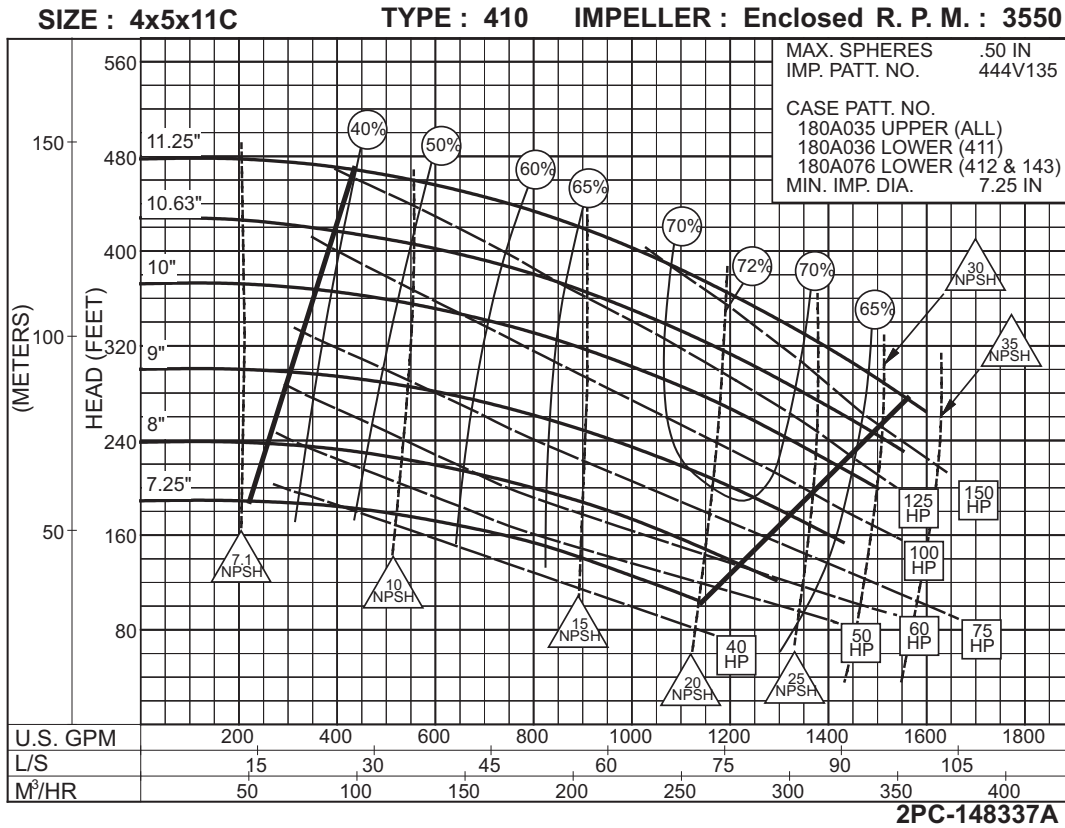

4 x 5 x 11D SERIES 410

ENCLOSED IMPELLER

SIZE : 4x5x11D TYPE : 410 IMPELLER : Enclosed R. P. M. : 3560

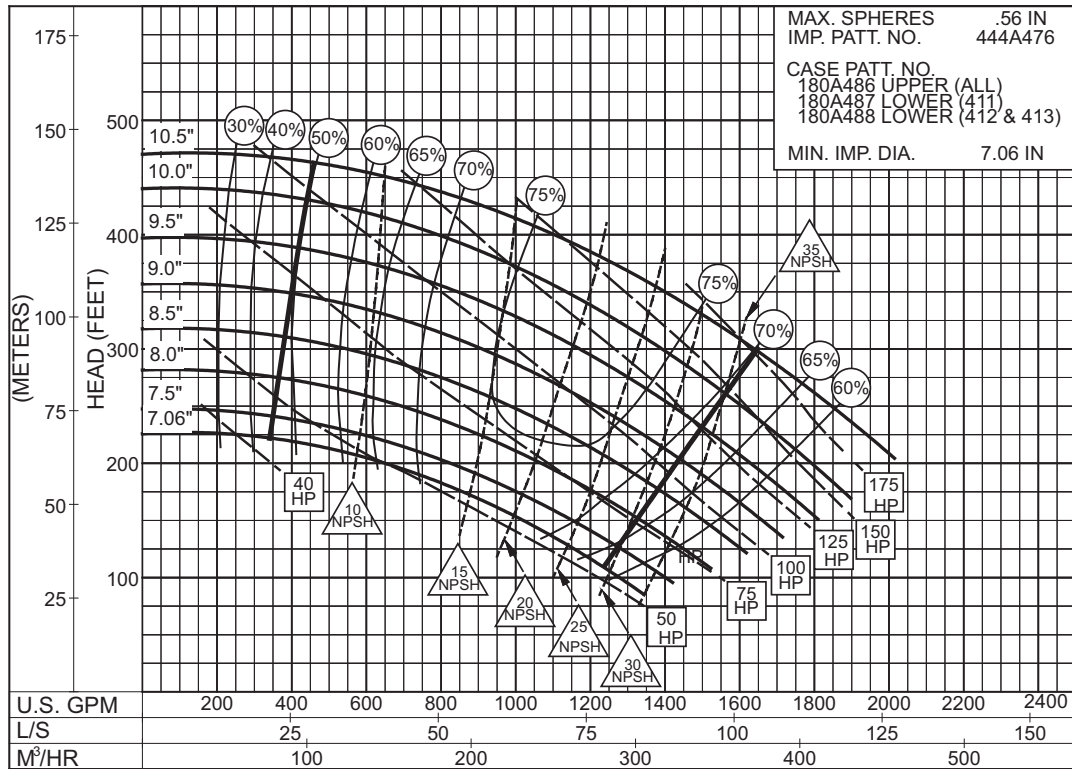

**3560
RPM**

PC -193673

SIZE : 4x5x11D TYPE : 410 IMPELLER : Enclosed R. P. M. : 1775

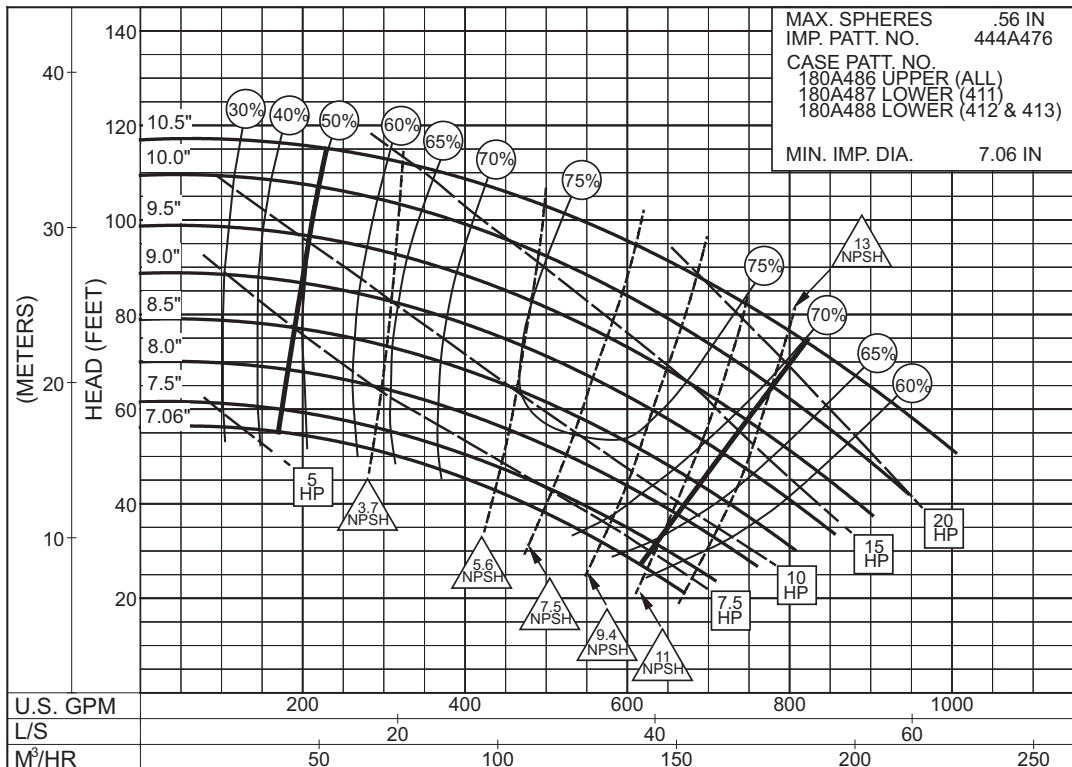

**1775
RPM**

PC -193674

4 x 5 x 15
SERIES 410

ENCLOSED IMPELLER

SIZE : 4x5x15 TYPE : 410 IMPELLER : Enclosed R. P. M. : 1775

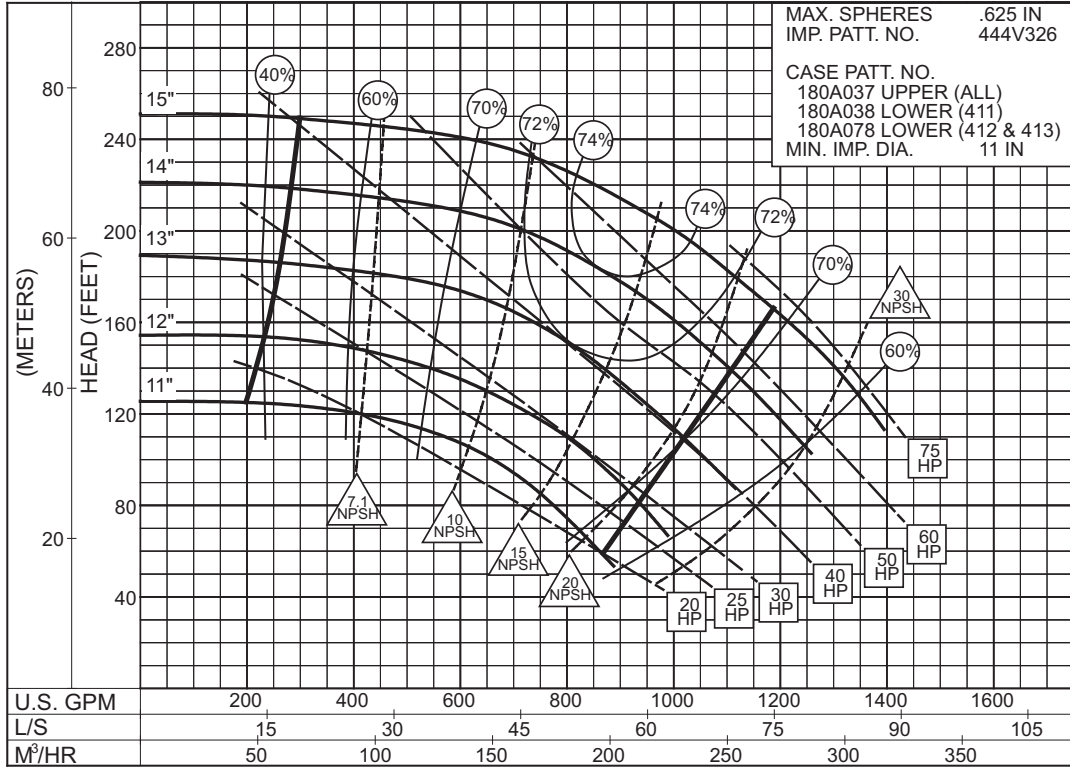

2PC-117373A

1775
RPM

SIZE : 4x5x15 TYPE : 410 IMPELLER : Enclosed R. P. M. : 1180

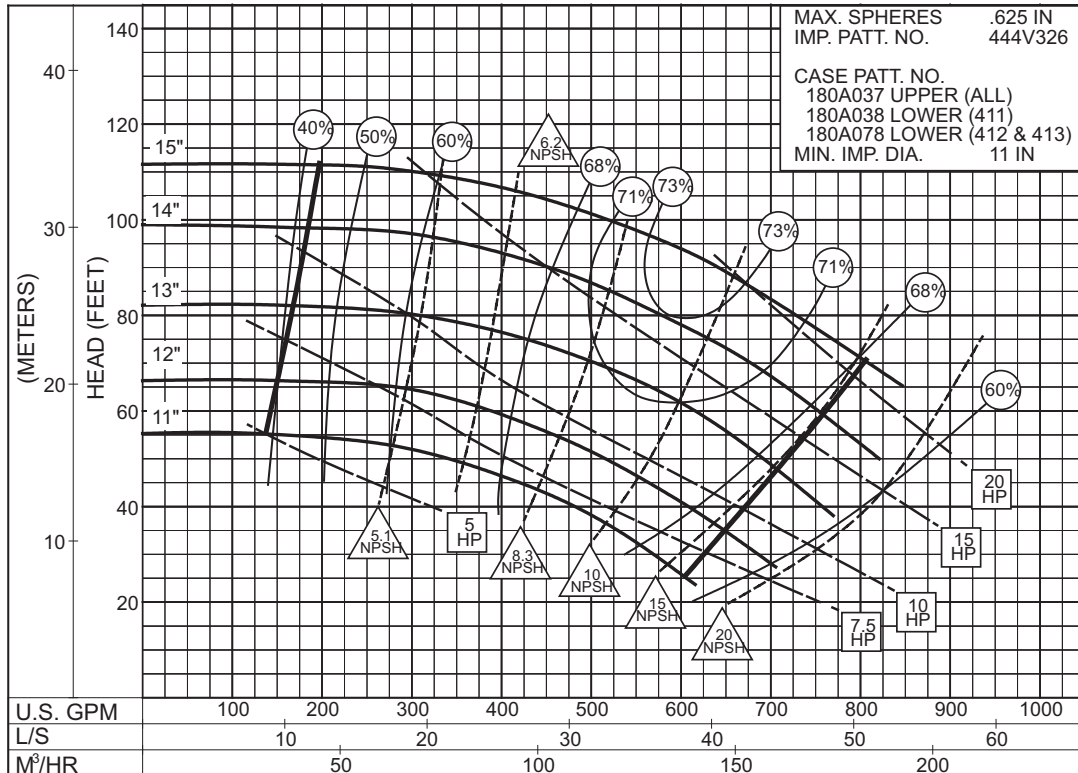

2PC-117374A

1180
RPM

4 x 6 x 18B SERIES 410

ENCLOSED IMPELLER

SIZE : 4x6x18B TYPE : 410 IMPELLER : Enclosed R. P. M. : 1775

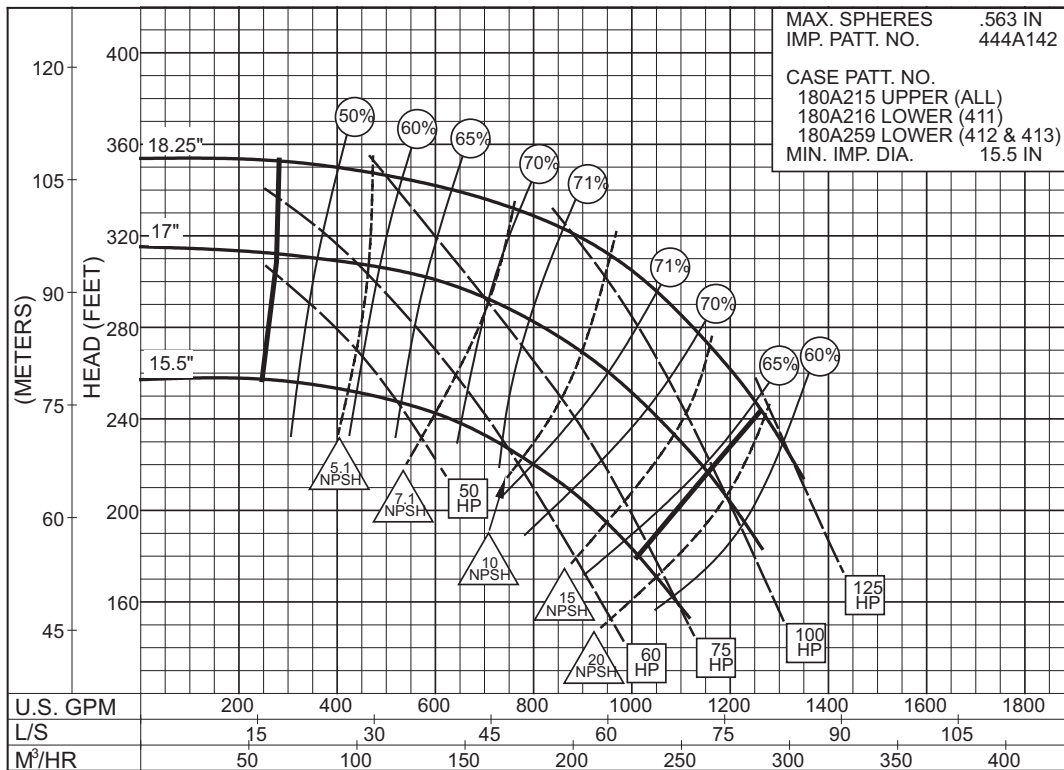

2PC-117375A

1775
RPM

SIZE : 4x6x18B TYPE : 410 IMPELLER : Enclosed R. P. M. : 1180

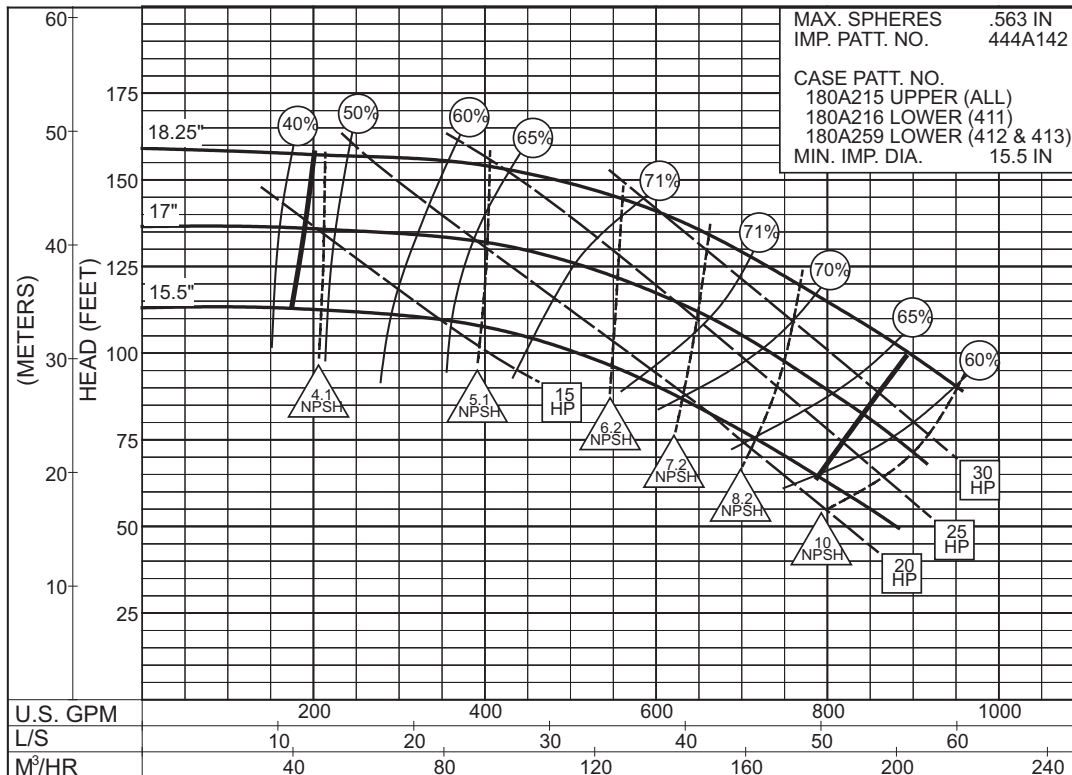

2PC-117376A

1180
RPM

5 x 6 x 11A
SERIES 410

ENCLOSED IMPELLER

SIZE : 5x6x11A TYPE : 410 IMPELLER : Enclosed R. P. M. : 1775

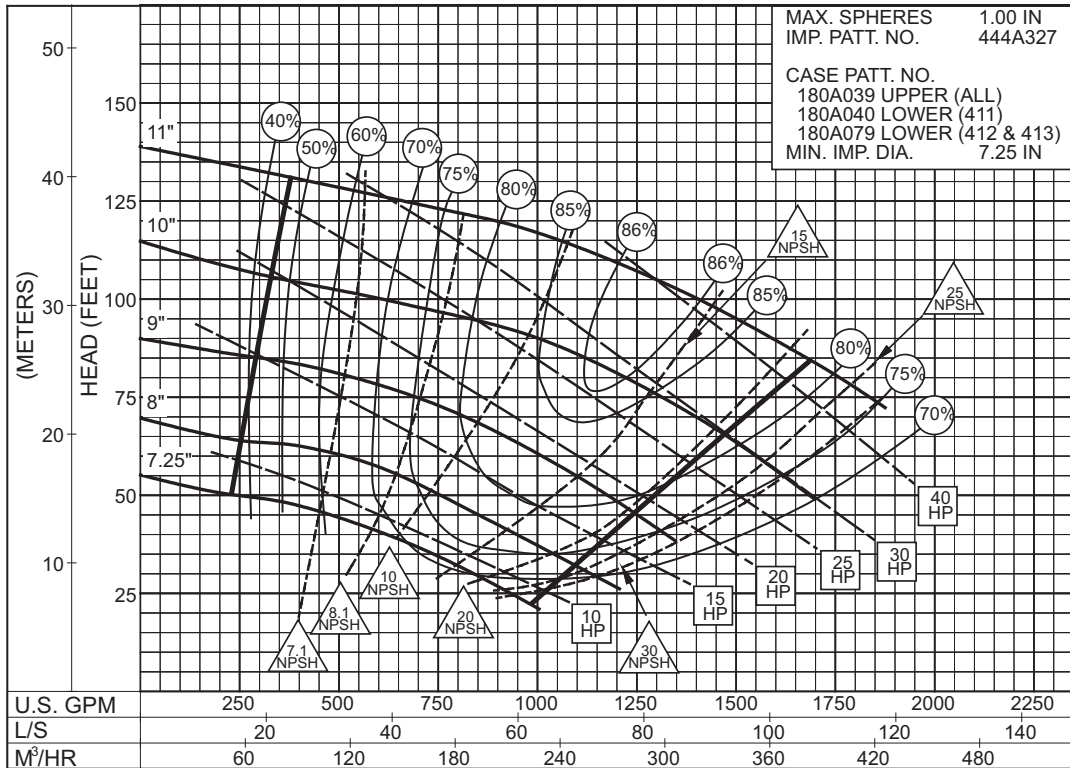

2JPC-117377A

1775
RPM

SIZE : 5x6x11A TYPE : 410 IMPELLER : Enclosed R. P. M. : 1180

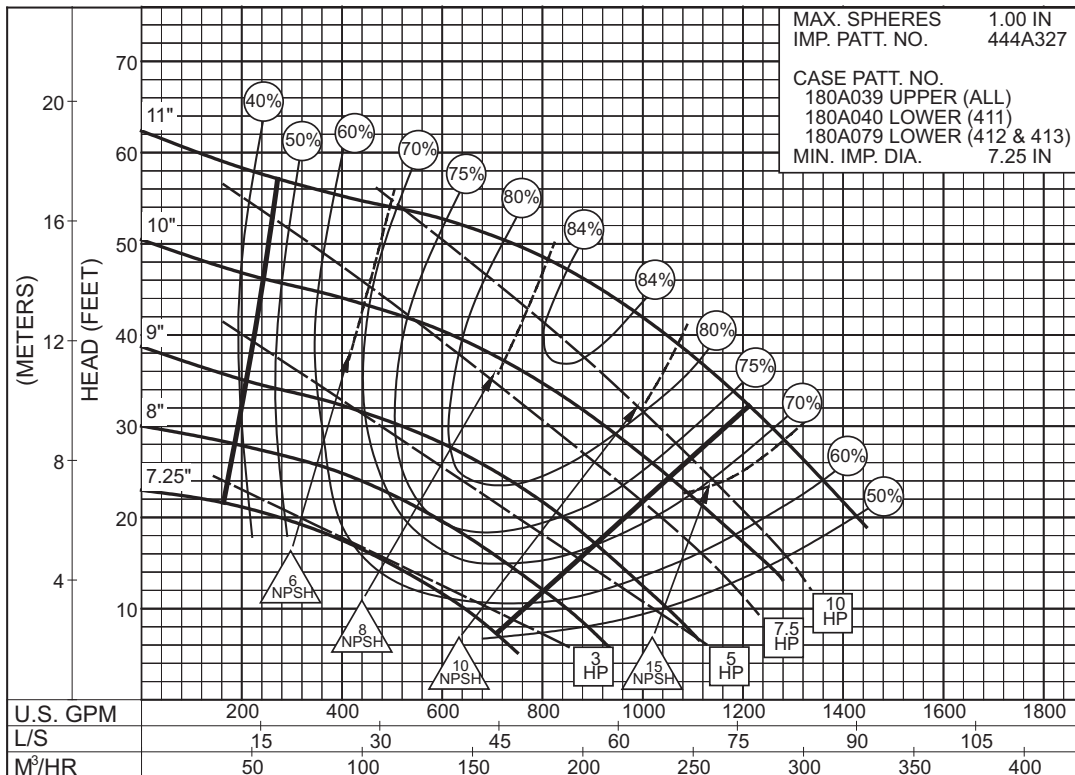

2PC-117378A

1180
RPM

5 x 6 x 11C SERIES 410

ENCLOSED IMPELLER

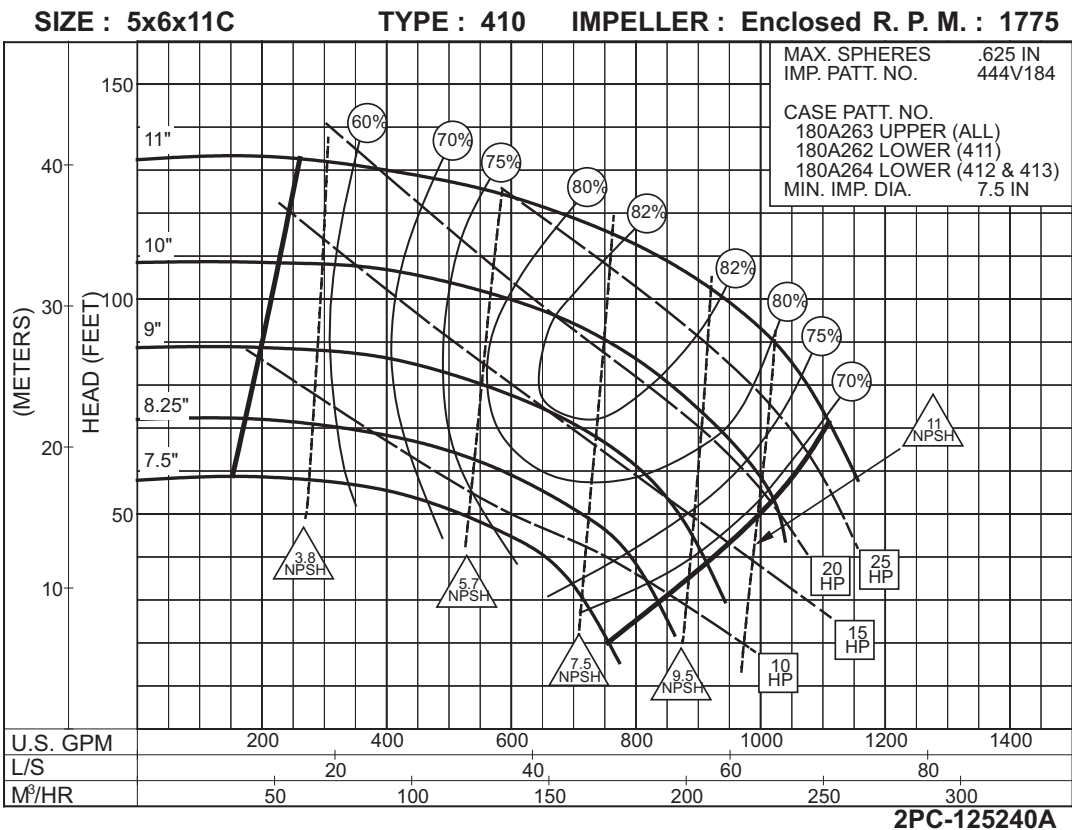
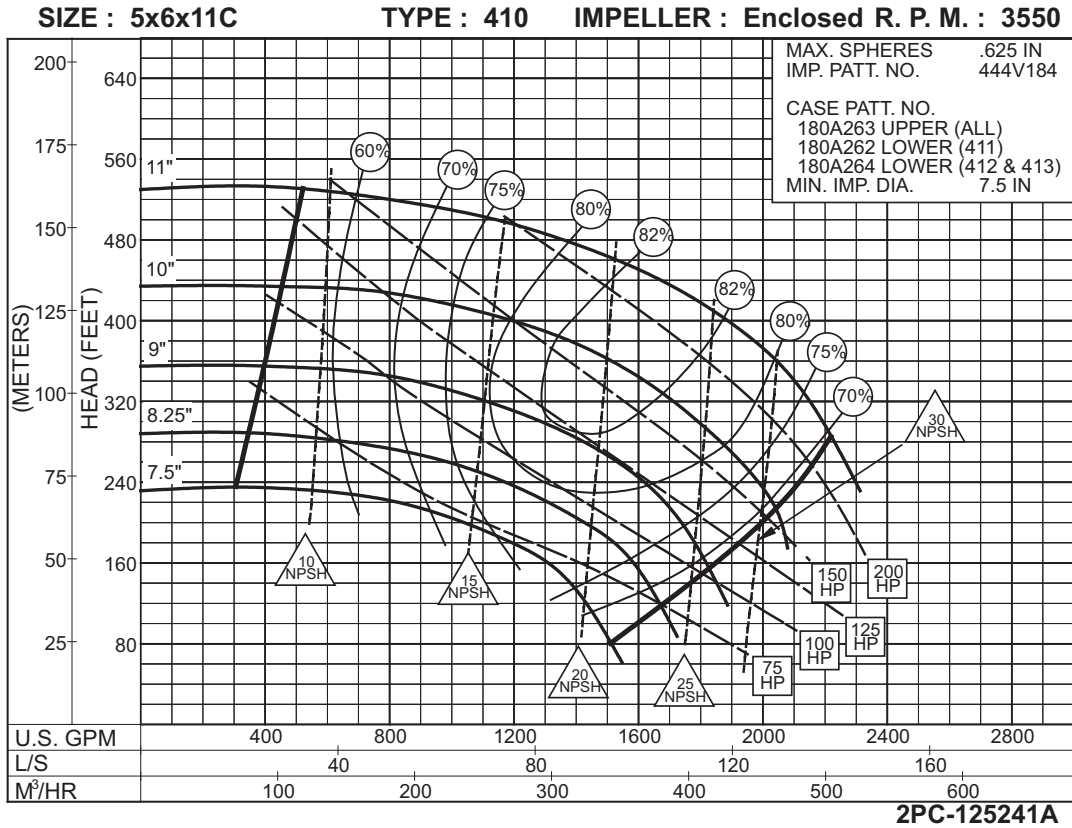

5 x 6 x 15
SERIES 410

ENCLOSED IMPELLER

SIZE : 5x6x15 TYPE : 410 IMPELLER : Enclosed R. P. M. : 1775

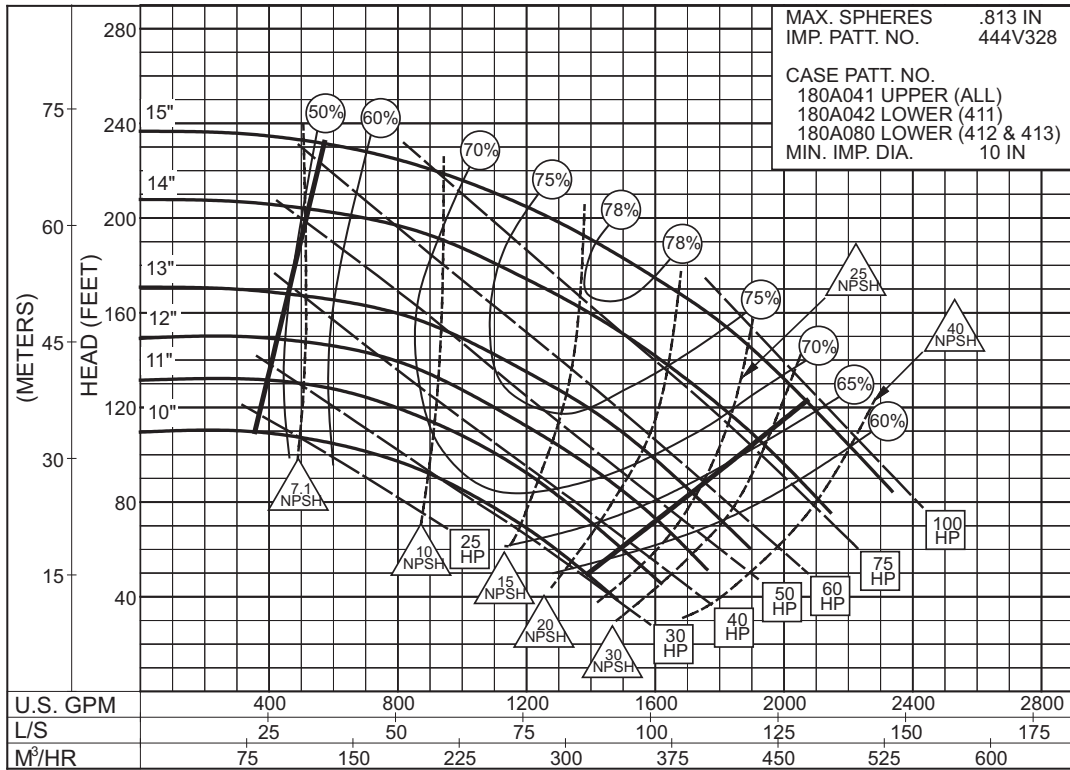

2PC-117379A

1775
RPM

SIZE : 5x6x15 TYPE : 410 IMPELLER : Enclosed R. P. M. : 1180

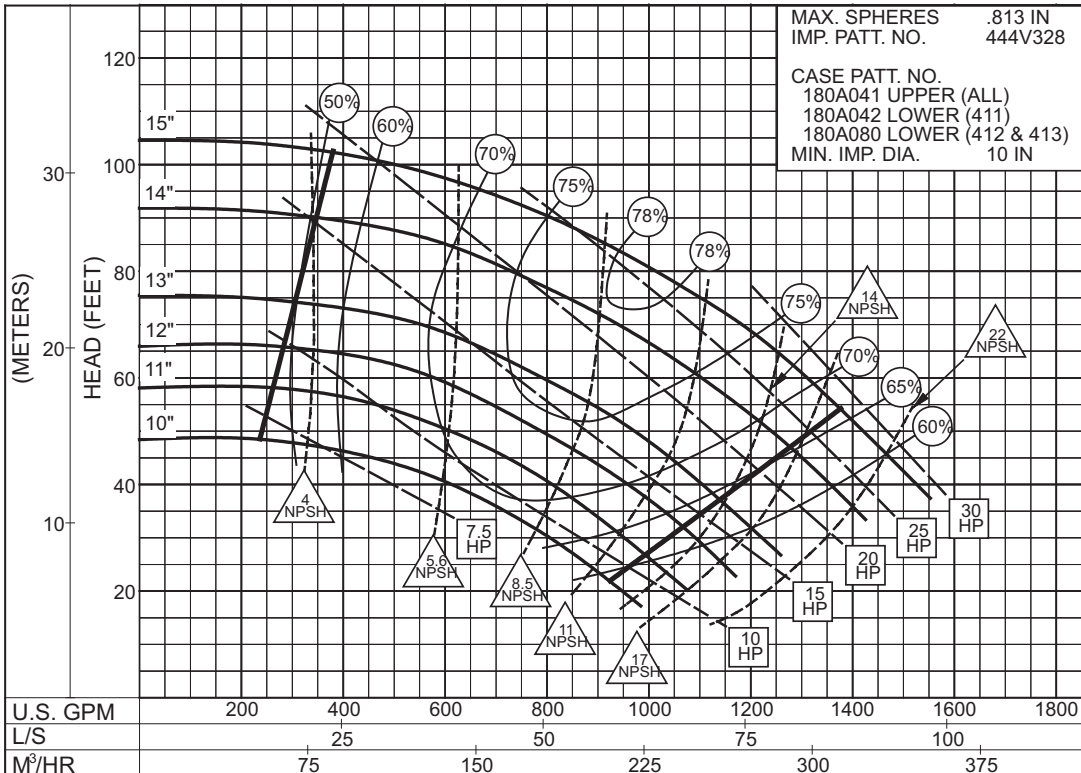

2PC-117380A

1180
RPM

5 x 6 x 17 SERIES 410

ENCLOSED IMPELLER

SIZE : 5x6x17 TYPE : 410 IMPELLER : Enclosed R. P. M. : 1775

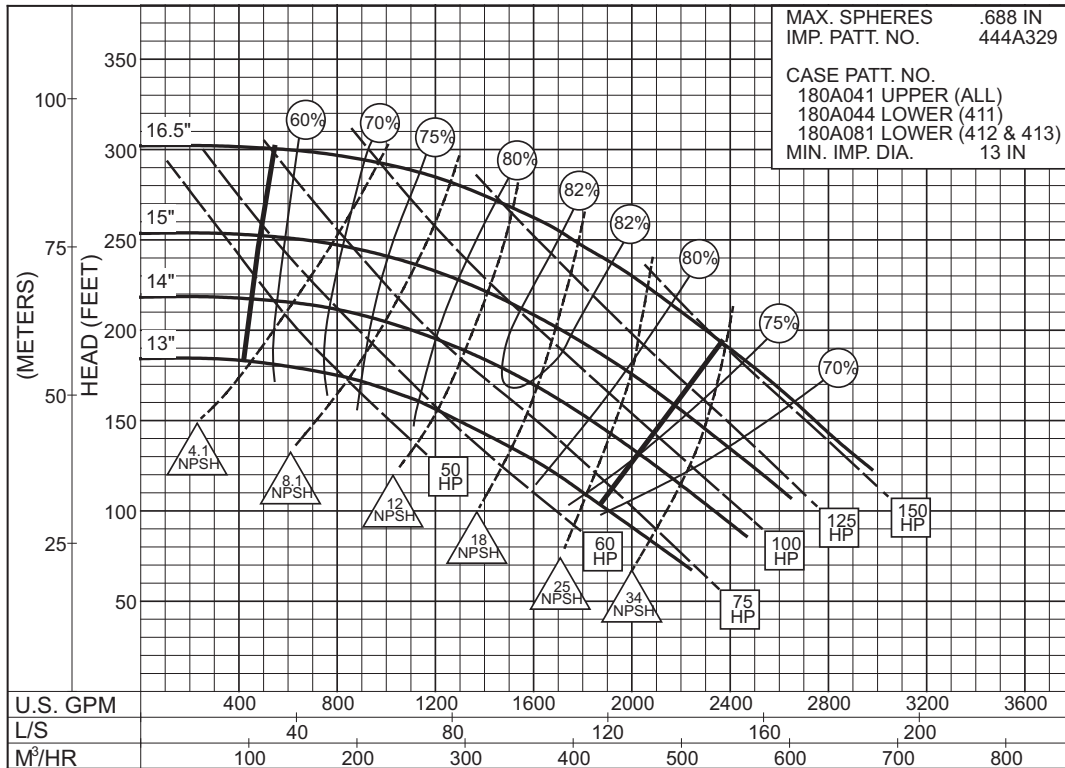

2PC-144788A

1775
RPM

SIZE : 5x6x17 TYPE : 410 IMPELLER : Enclosed R. P. M. : 1180

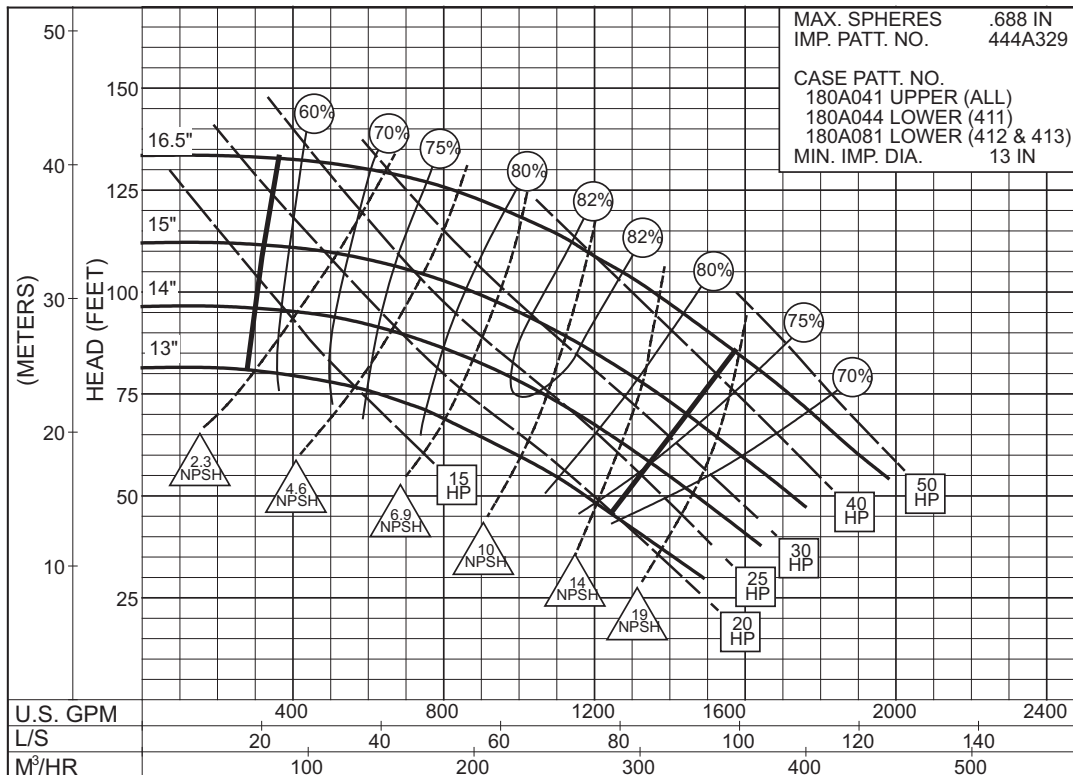

2PC-144789A

1180
RPM

6 x 8 x 11 SERIES 410

ENCLOSED IMPELLER

SIZE : 6x8x11 TYPE : 410 IMPELLER : Enclosed R. P. M. : 1775

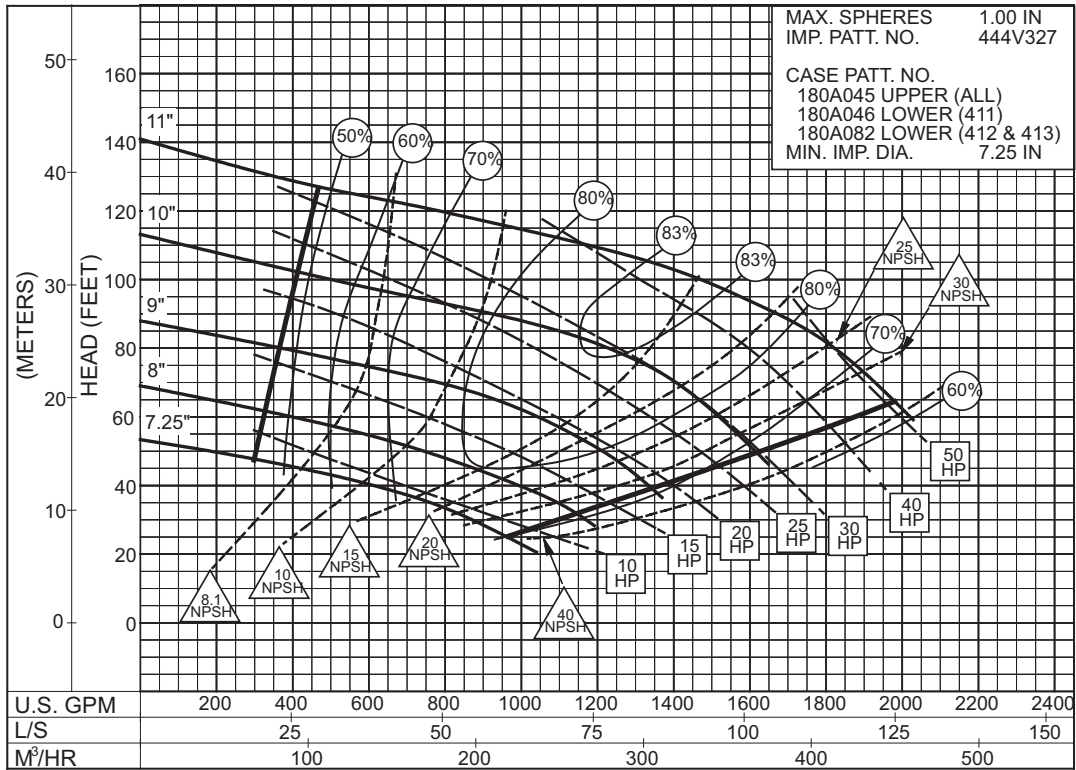

2PC-117383A

1775
RPM

SIZE : 6x8x11 TYPE : 410 IMPELLER : Enclosed R. P. M. : 1180

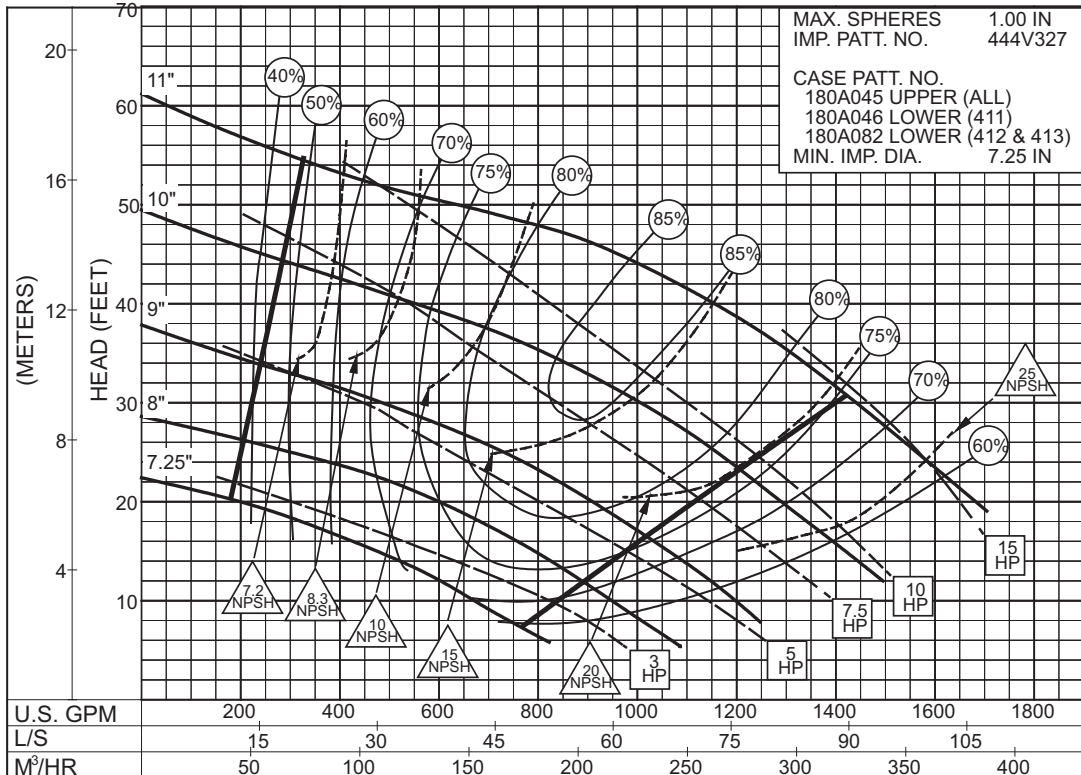

2PC-117384A

1180
RPM

6x8x11HH SERIES 410

ENCLOSED IMPELLER

SIZE : 6x8x11HH TYPE : 410 IMPELLER : Enclosed R. P. M. : 3560

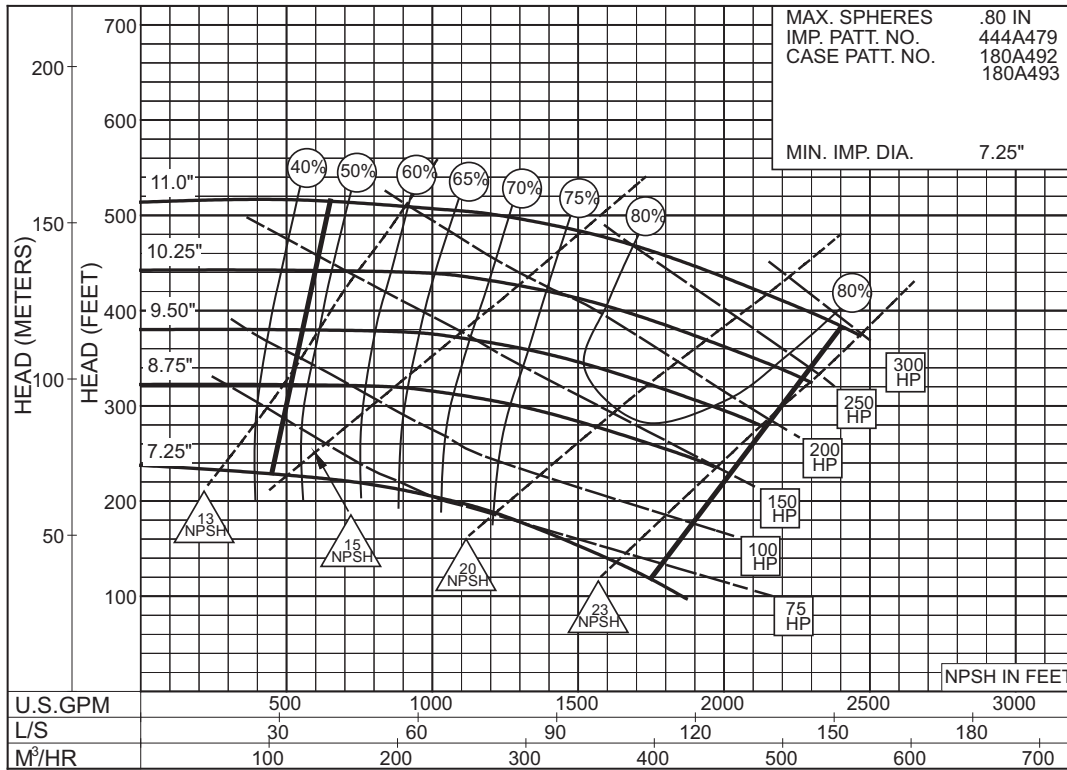

3560
RPM

PC - 186564

**6x8x14HH
SERIES 410**

ENCLOSED IMPELLER

SIZE : 6x8x14HH TYPE : 410 IMPELLER : Enclosed R. P. M. : 3560

MAX. SPHERES .63 IN
IMP. PATT. NO. 444A447
CASE PATT. NO. 180A489
180A490

MIN. IMP. DIA. 9.0"

**3560
RPM**

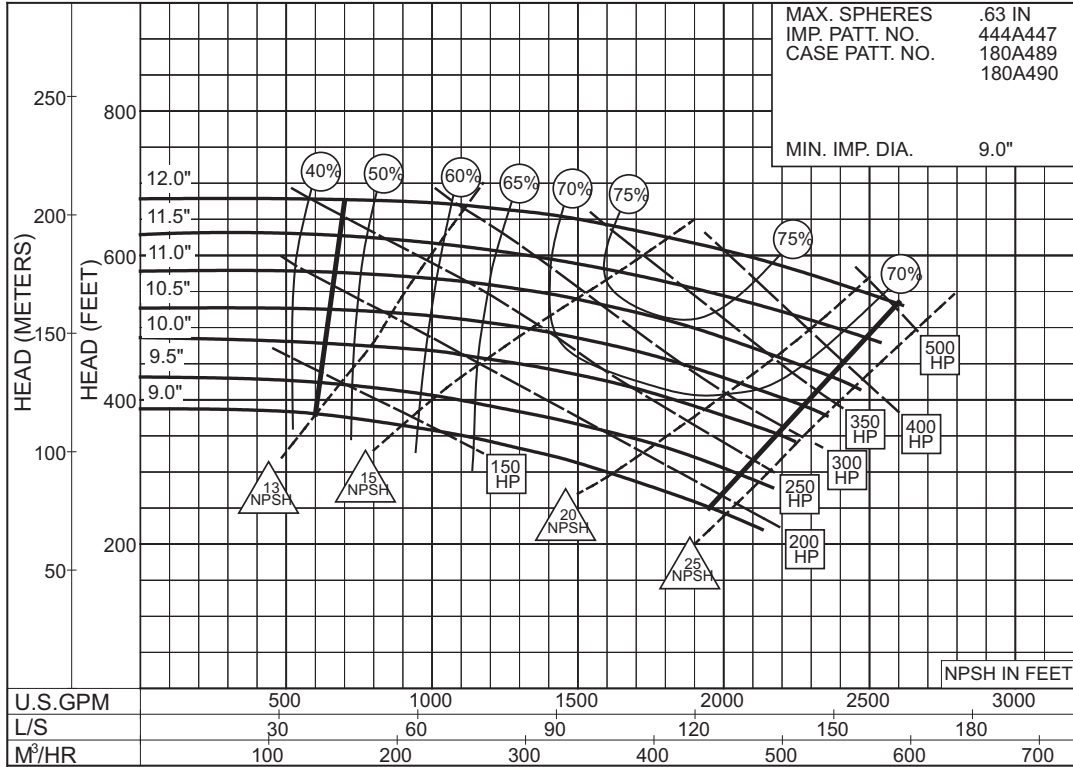

PC - 190631

6 x 8 x 15 SERIES 410

ENCLOSED IMPELLER

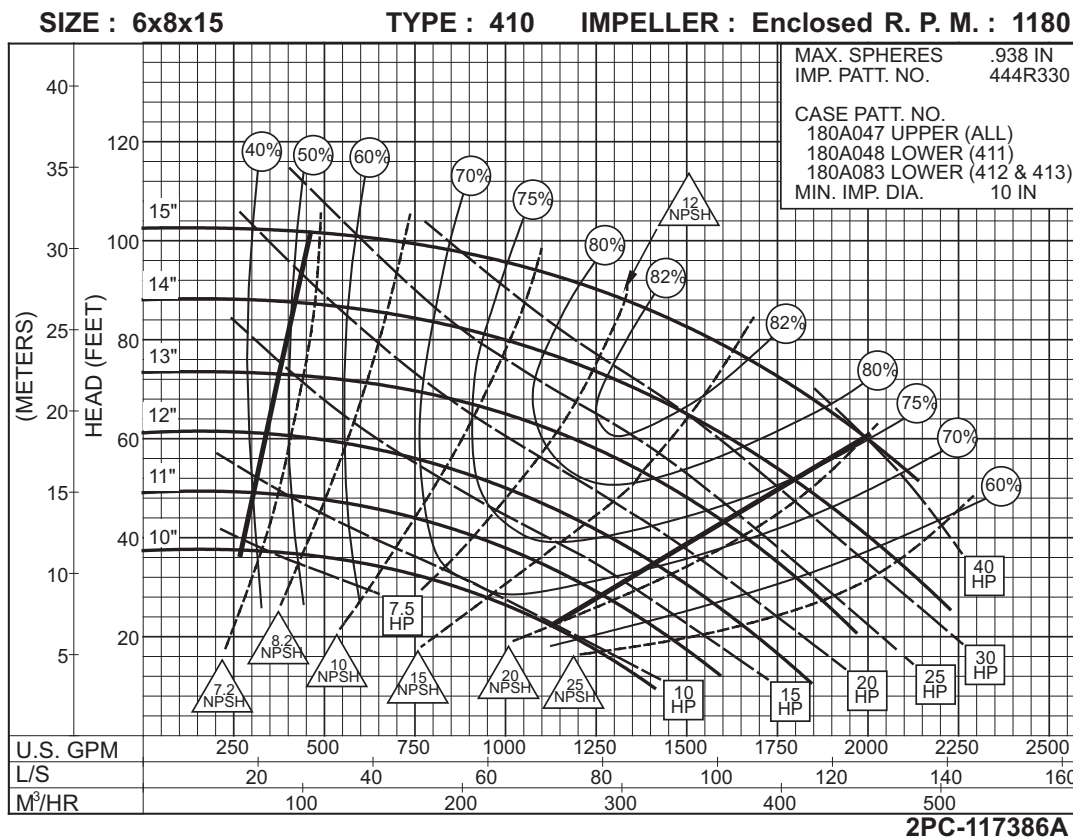
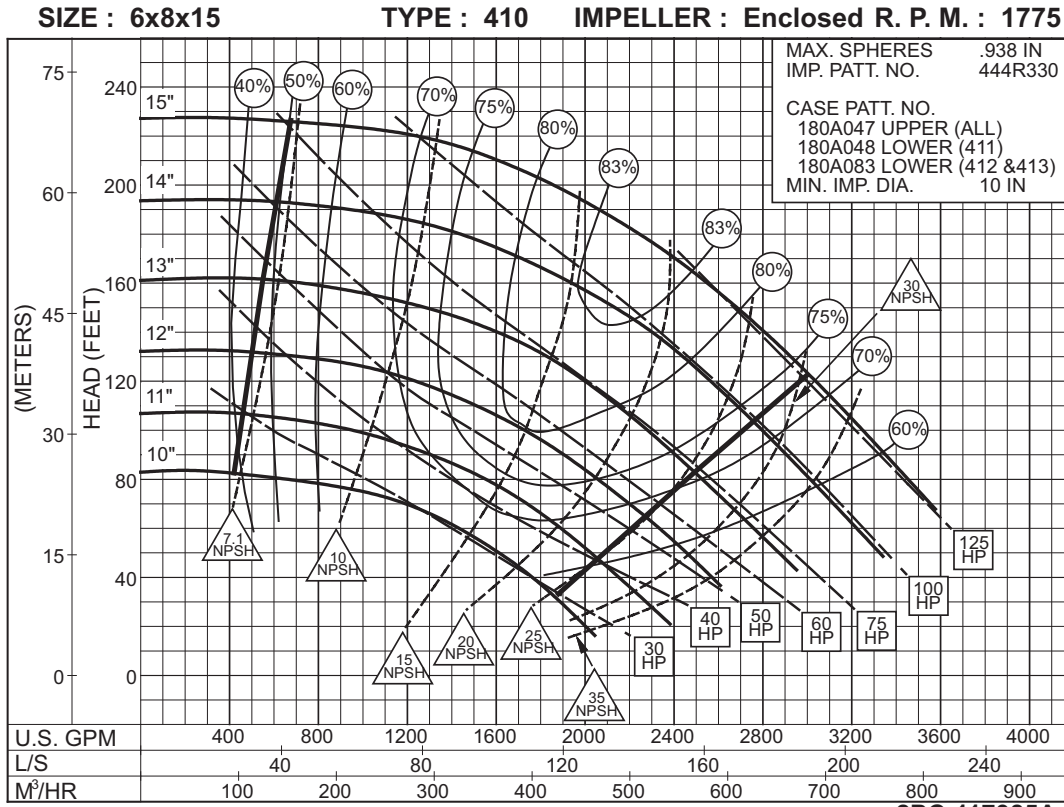

6 x 8 x 18A SERIES 410

ENCLOSED IMPELLER

SIZE : 6x8x18A TYPE : 410 IMPELLER : Enclosed R. P. M. : 1775

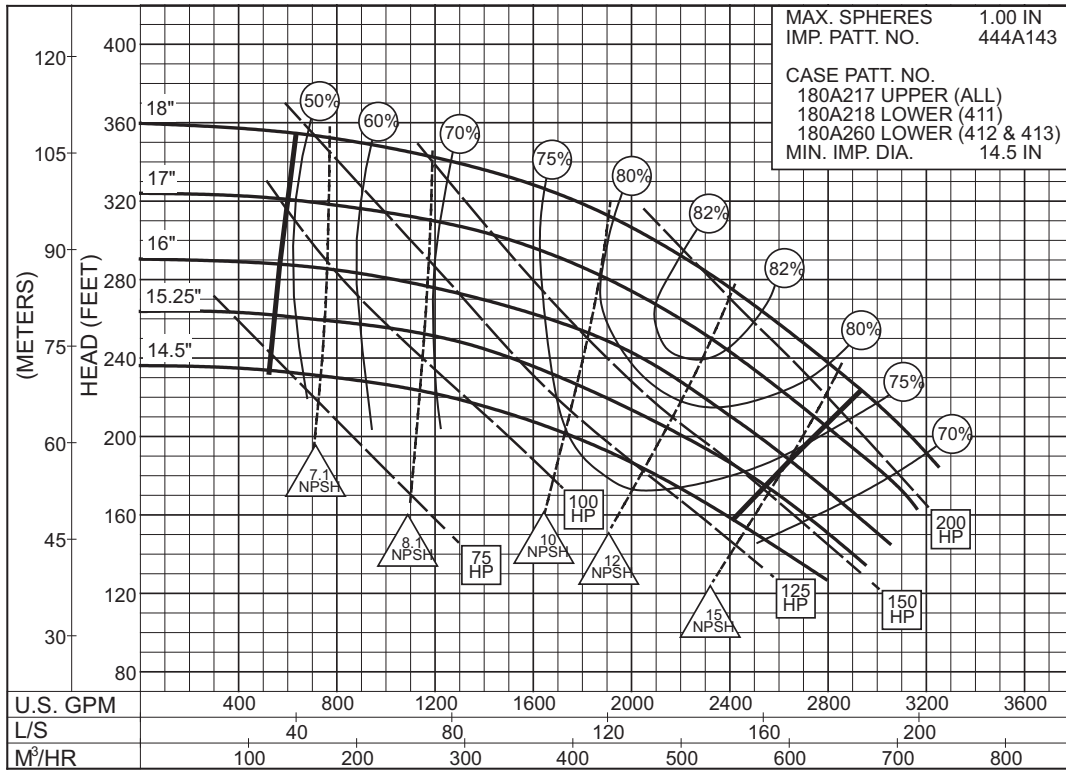

2PC-125666A

1775
RPM

SIZE : 6x8x18A TYPE : 410 IMPELLER : Enclosed R. P. M. : 1150

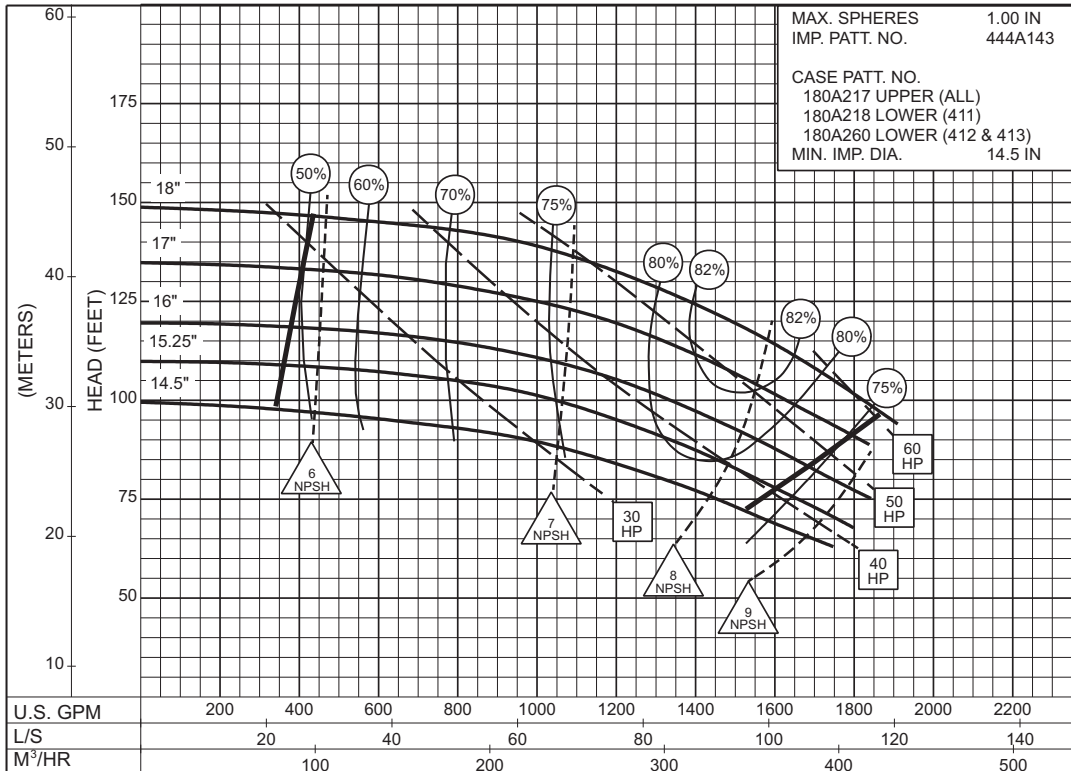

2PC-125667

1150
RPM

6 x 8 x 18B SERIES 410

ENCLOSED IMPELLER

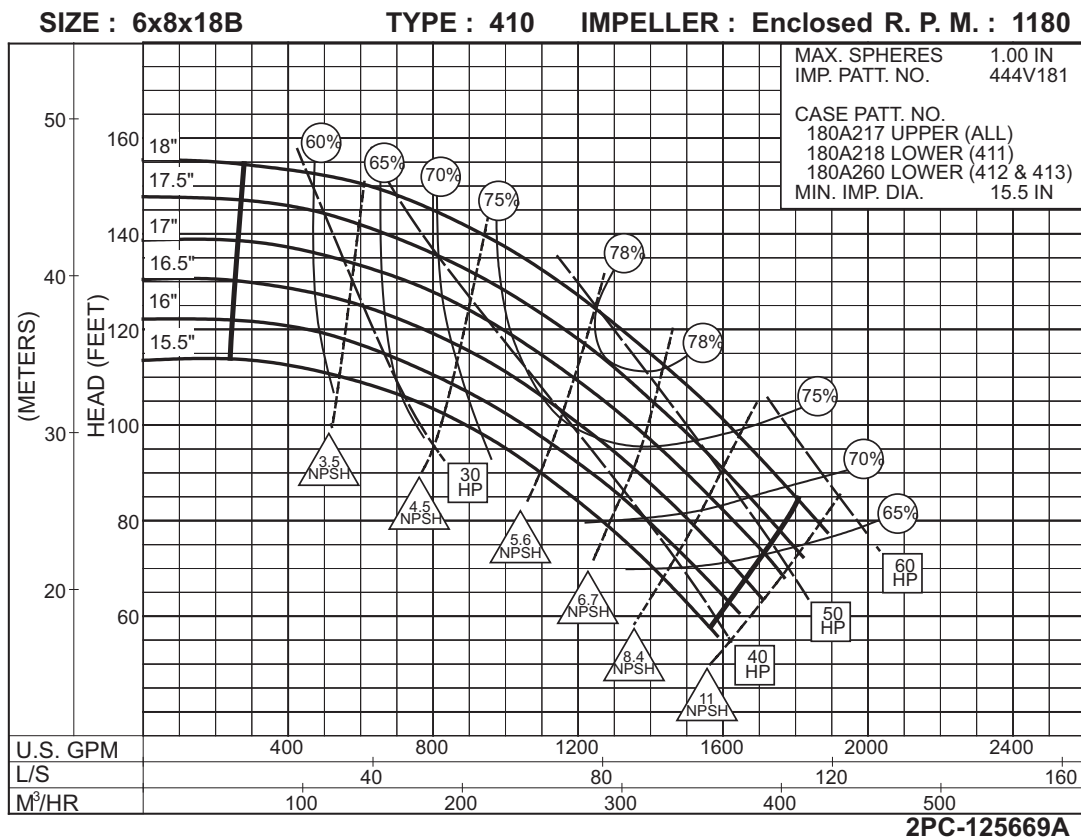
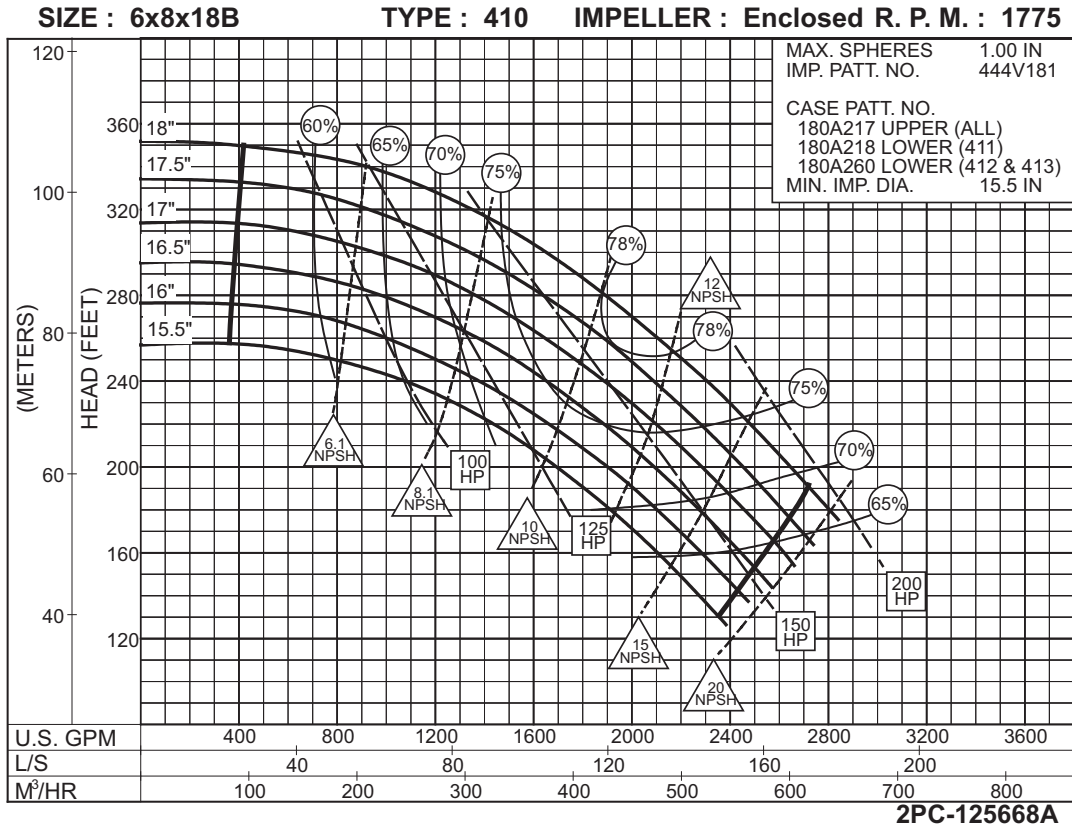

6 x 8 x18C SERIES 410

ENCLOSED IMPELLER

SIZE : 6x8x18C TYPE : 410 IMPELLER : Enclosed R. P. M. : 1775

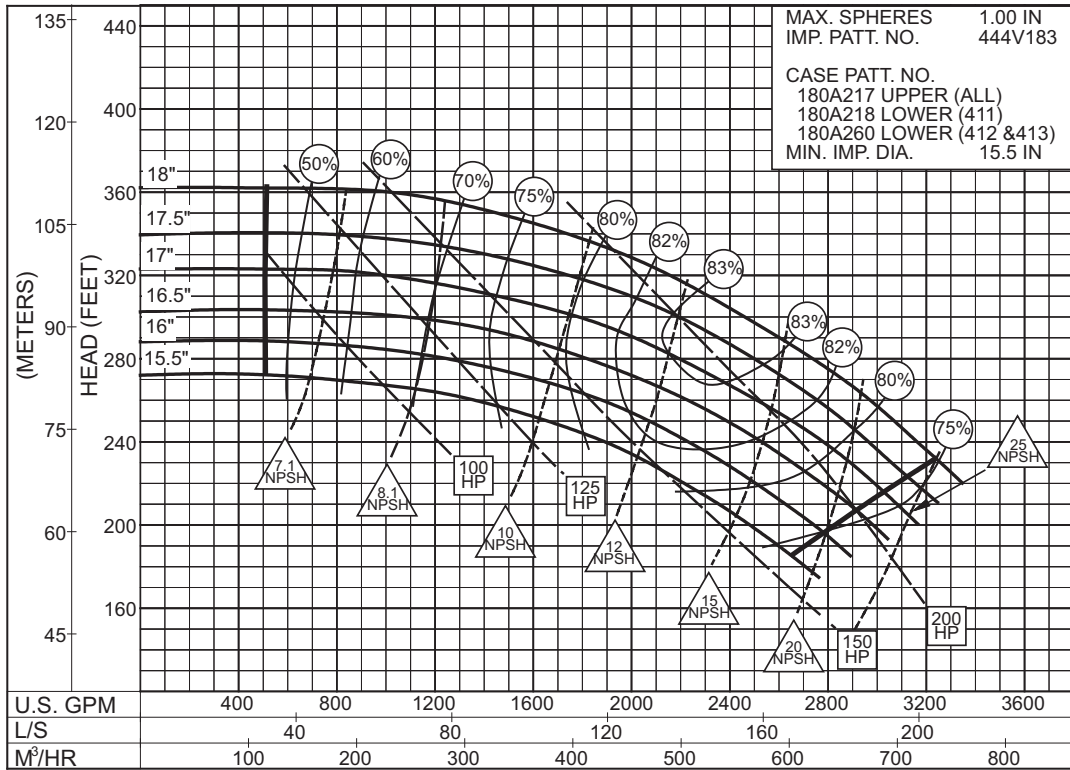

2PC-125670A

1775
RPM

SIZE : 6x8x18C TYPE : 410 IMPELLER : Enclosed R. P. M. : 1180

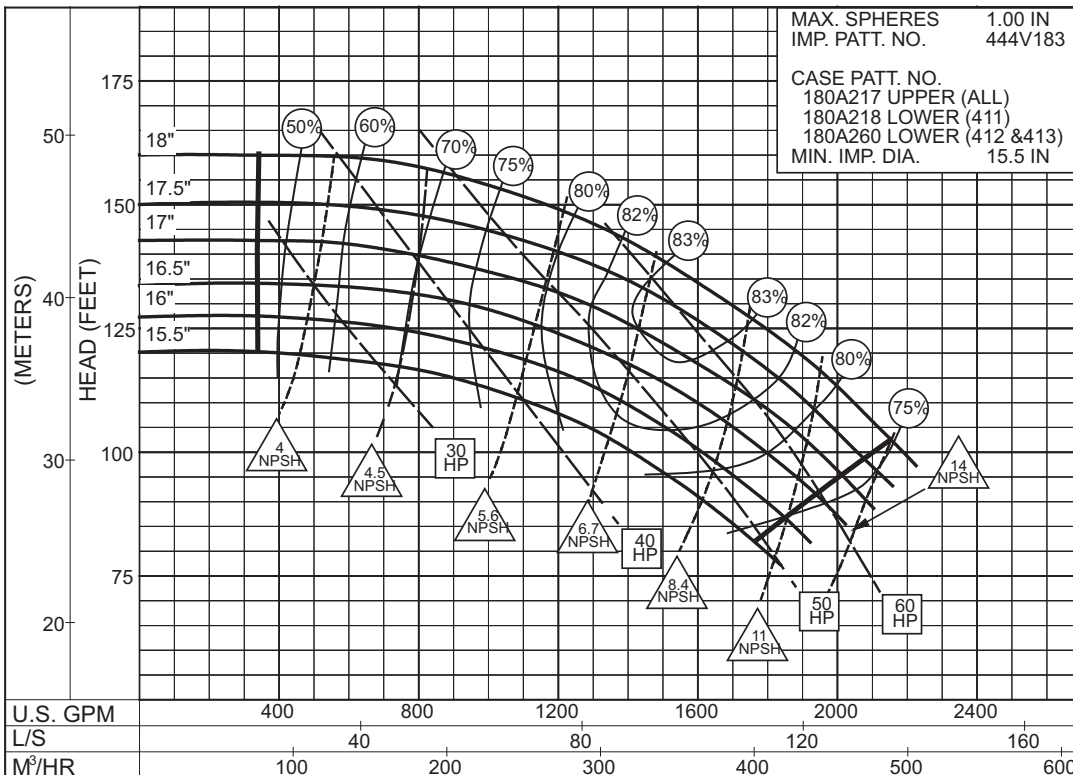

2PC-125671A

1180
RPM

6 x 8 x 20 SERIES 410

ENCLOSED IMPELLER

SIZE : 6x8x20 TYPE : 410 IMPELLER : Enclosed R. P. M. : 1780

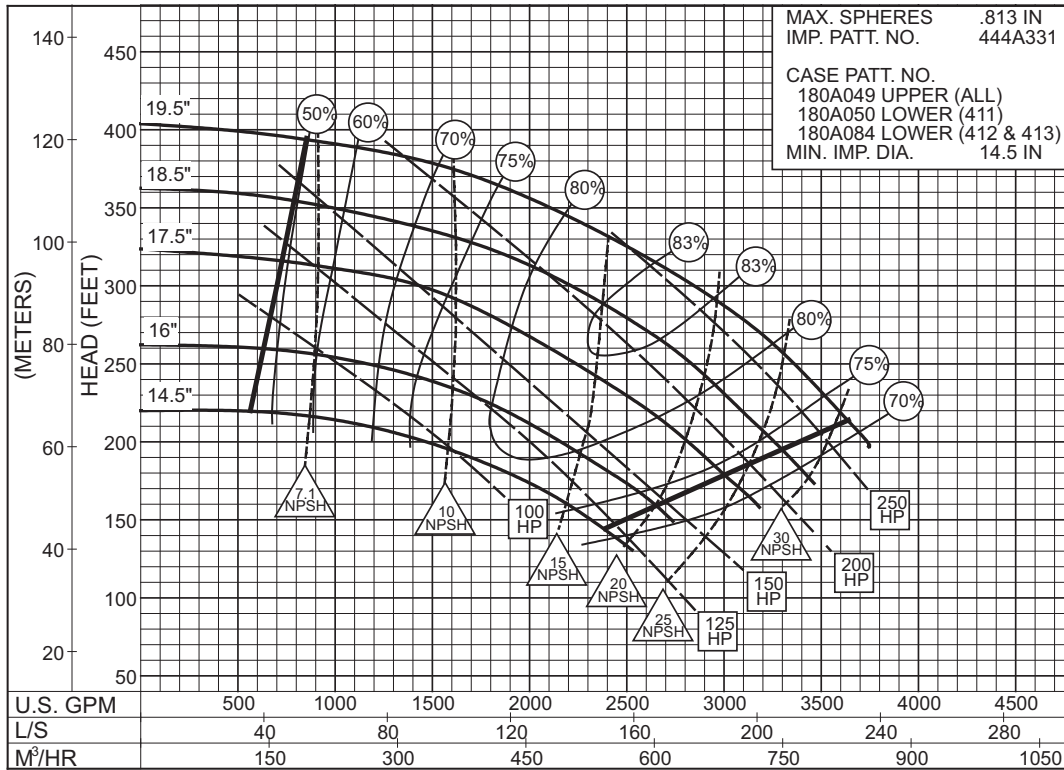

2PC-117389A



SIZE : 6x8x20 TYPE : 410 IMPELLER : Enclosed R. P. M. : 1175

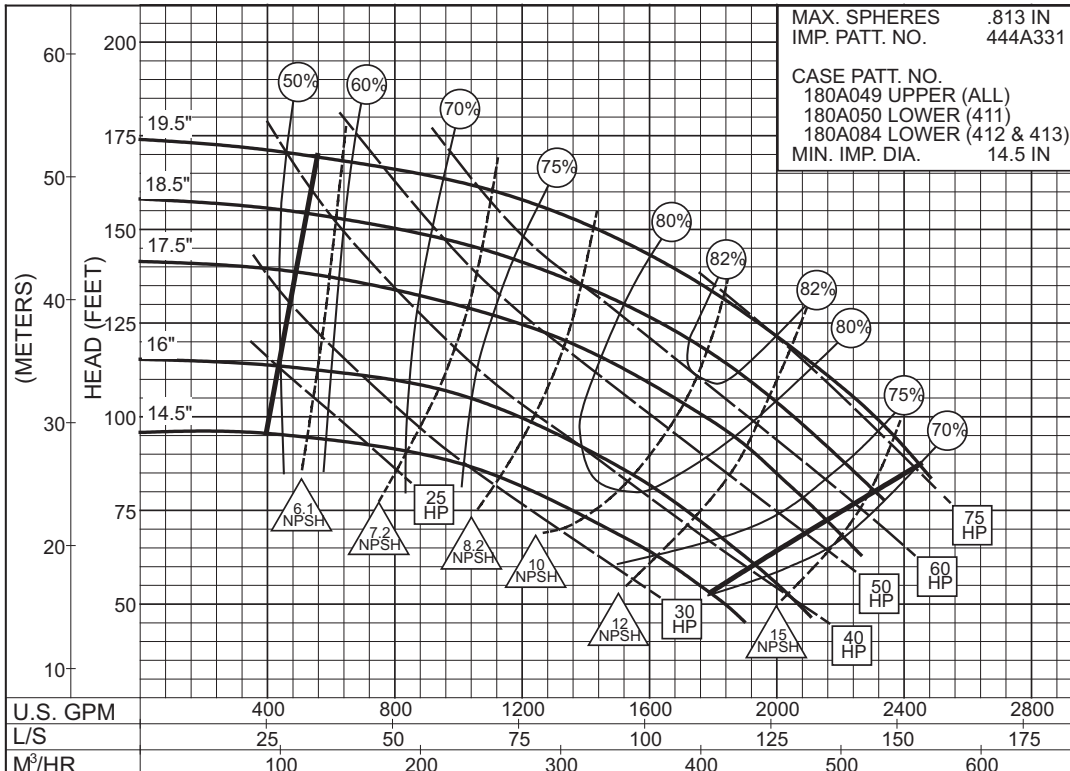

2PC-117390A



8 x 8 x 11B SERIES 410

ENCLOSED IMPELLER

SIZE : 8x8x11B TYPE : 410 IMPELLER : Enclosed R. P. M. : 1775

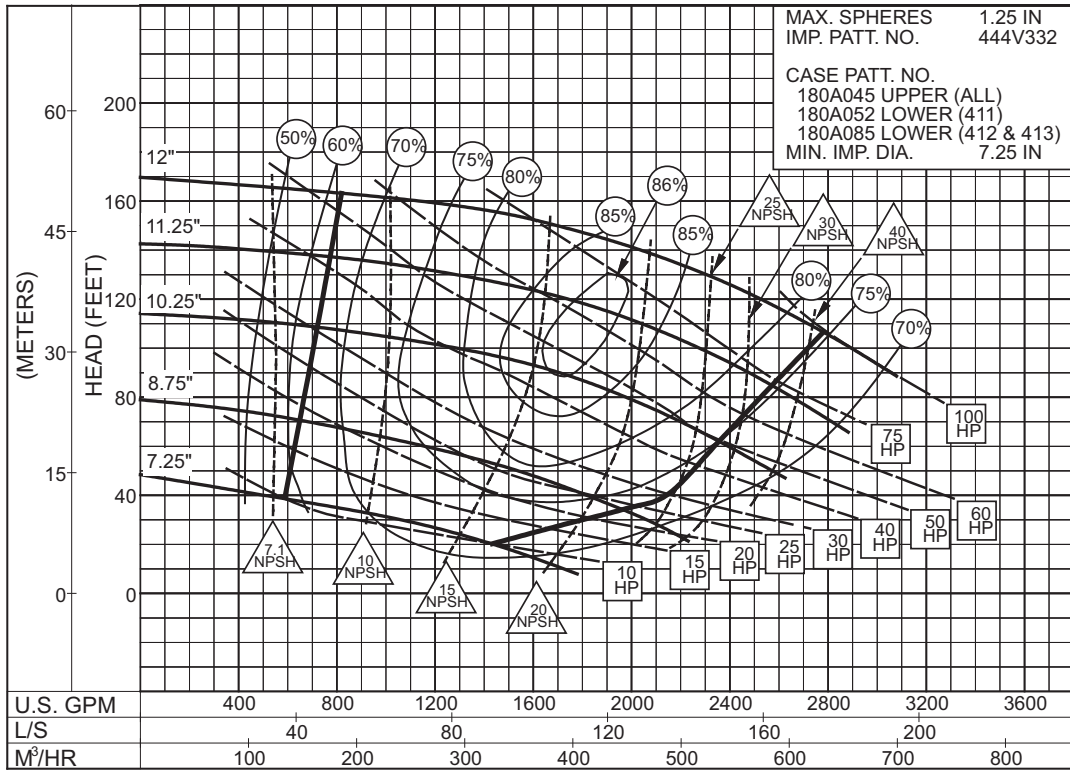

2PC-131637A

1775
RPM

SIZE : 8x8x11B TYPE : 410 IMPELLER : Enclosed R. P. M. : 1180

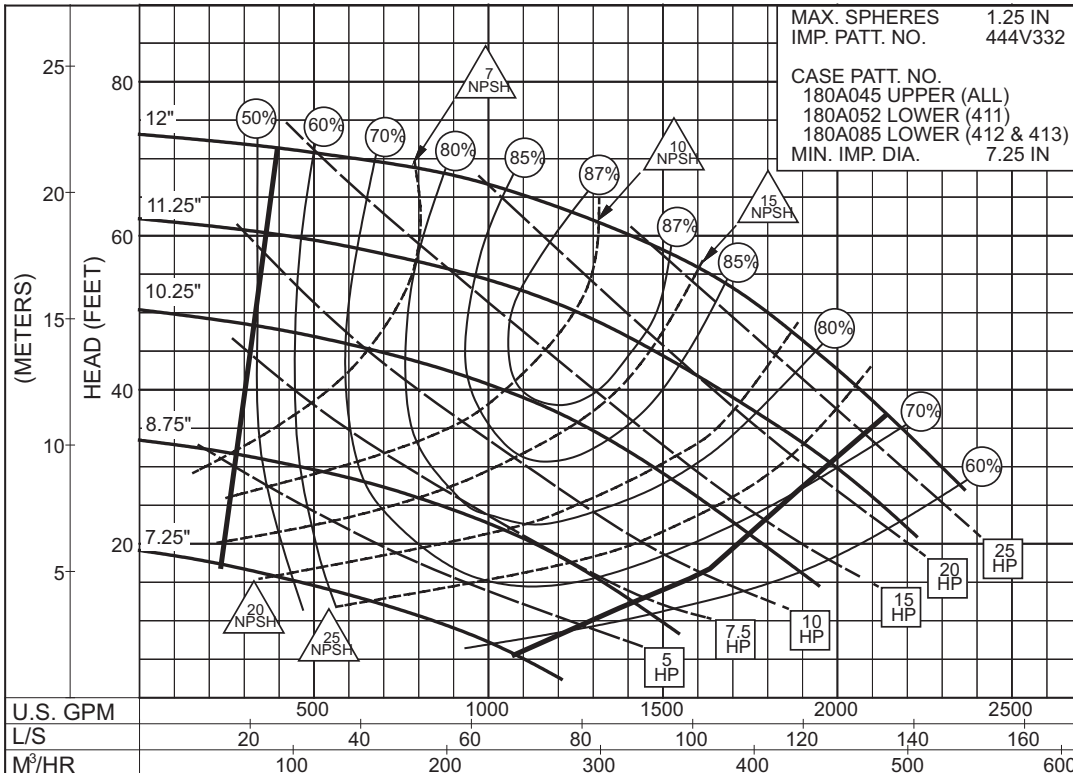

2PC-131638A

1180
RPM

8 x 10 x 12 SERIES 410

ENCLOSED IMPELLER

SIZE : 8x10x12 TYPE : 410 IMPELLER : Enclosed R. P. M. : 1775

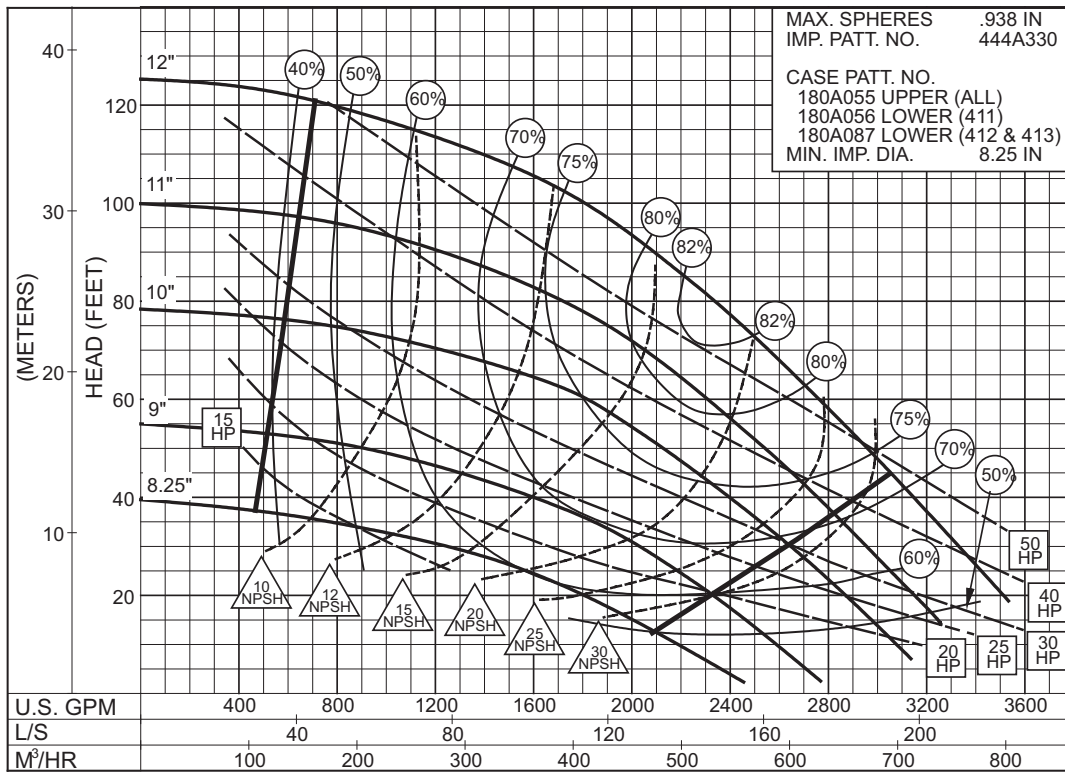

2PC-117393A

1775
RPM

SIZE : 8x10x12 TYPE : 410 IMPELLER : Enclosed R. P. M. : 1180

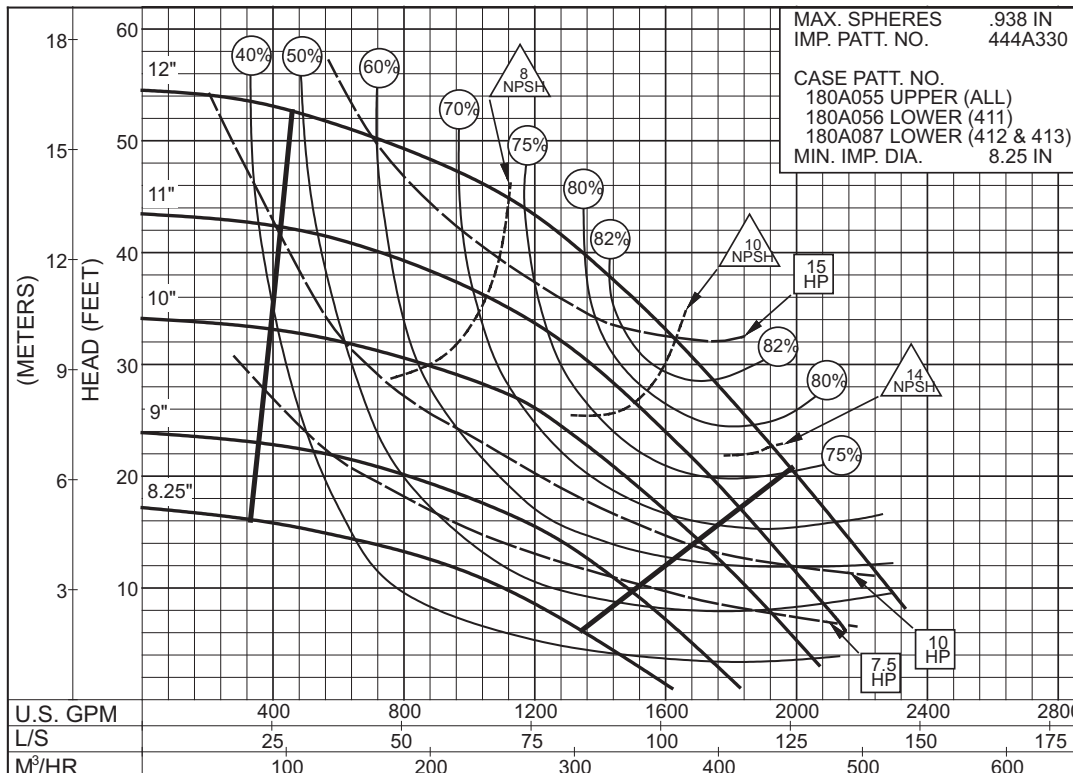

2PC-117394A

1180
RPM

8 x 10 x 12A SERIES 410

ENCLOSED IMPELLER

SIZE : 8x10x12A TYPE : 410 IMPELLER : Enclosed R. P. M. : 1775

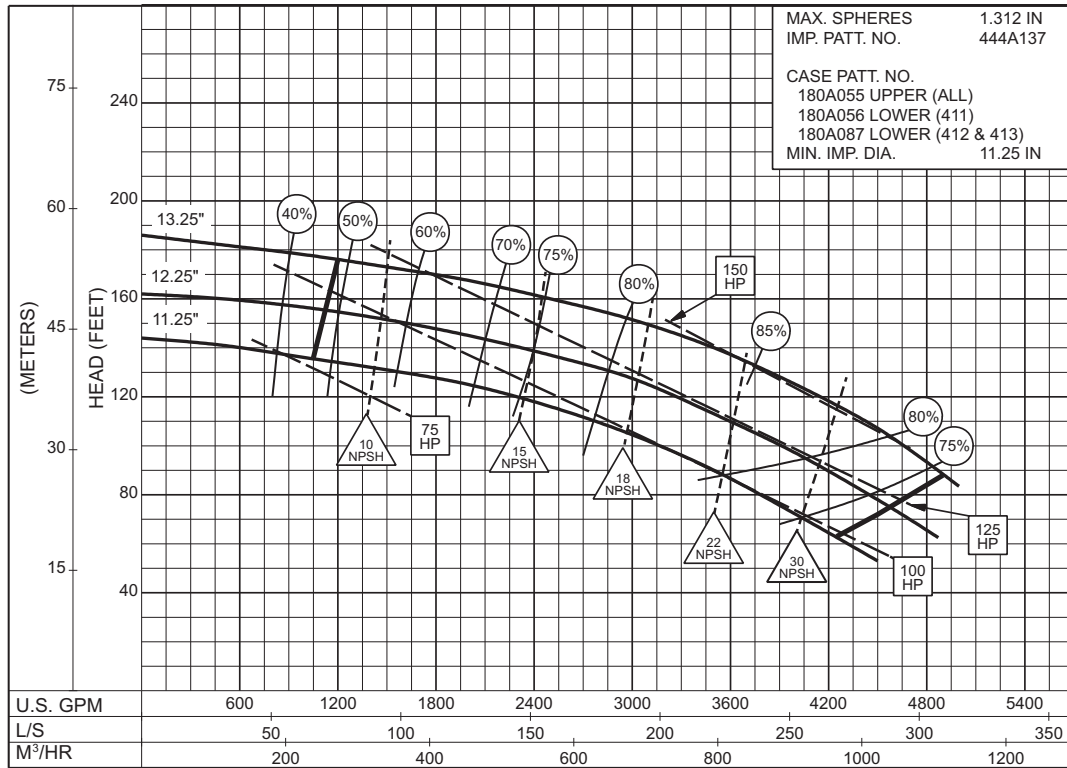

2PC-146000

1775
RPM

SIZE : 8x10x12A TYPE : 410 IMPELLER : Enclosed R. P. M. : 1175

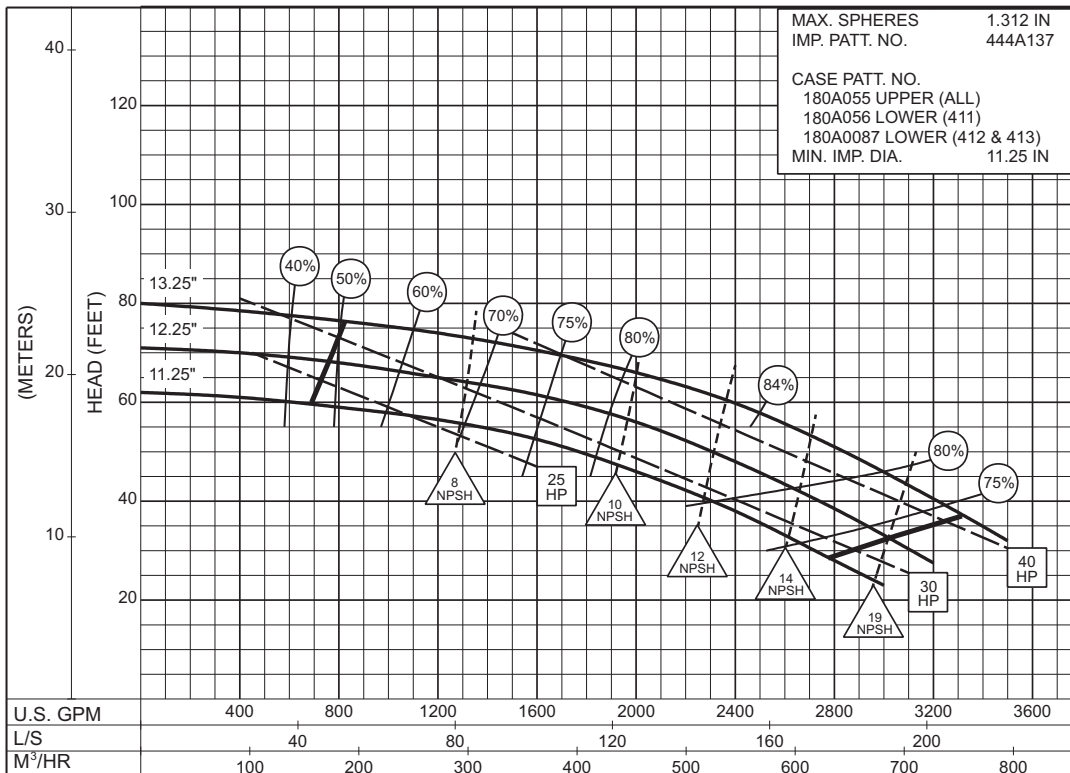

2PC-145999

1175
RPM

8 x 10 x 15A SERIES 410

ENCLOSED IMPELLER

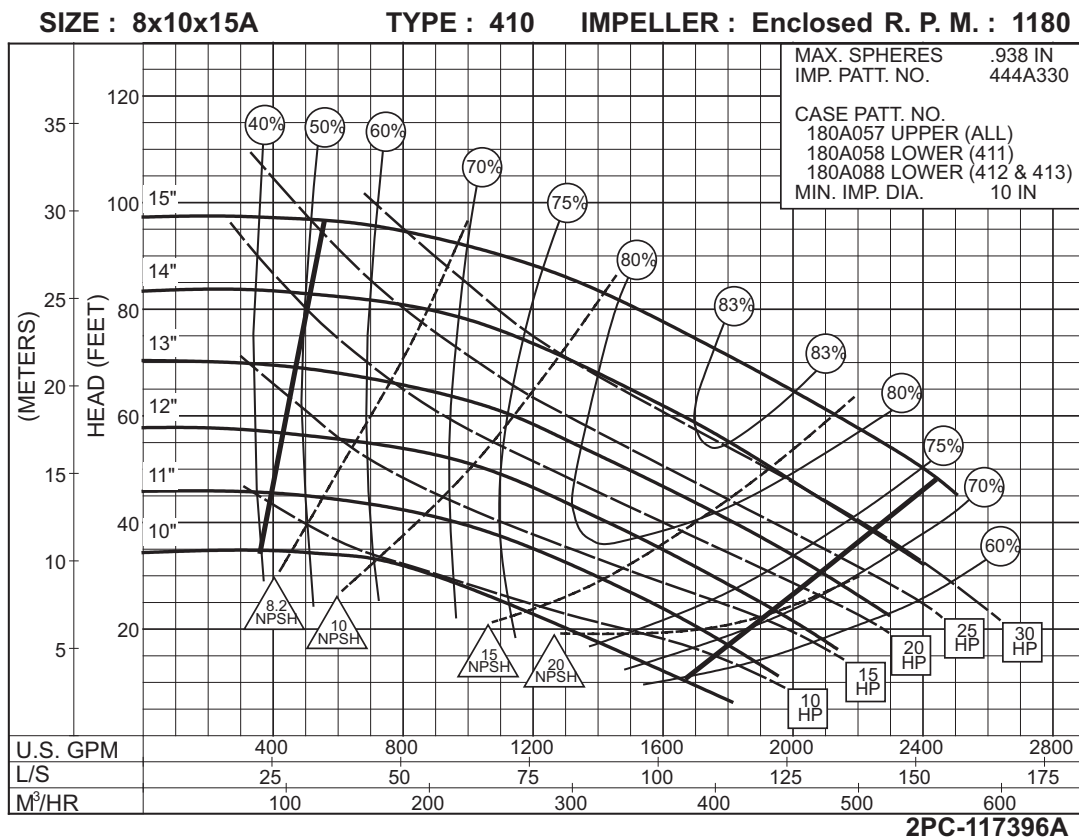
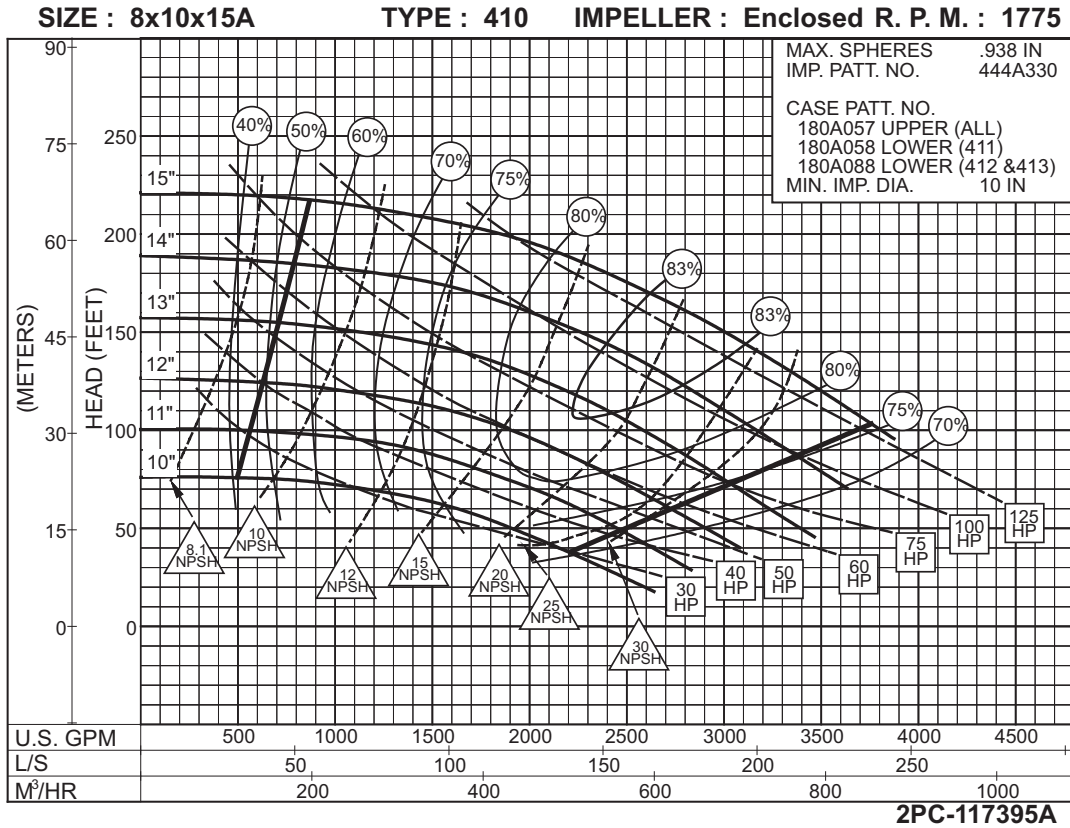

8 x 10 x 15B
SERIES 410

ENCLOSED IMPELLER

SIZE : 8x10x15B TYPE : 410 IMPELLER : Enclosed R. P. M. : 1775

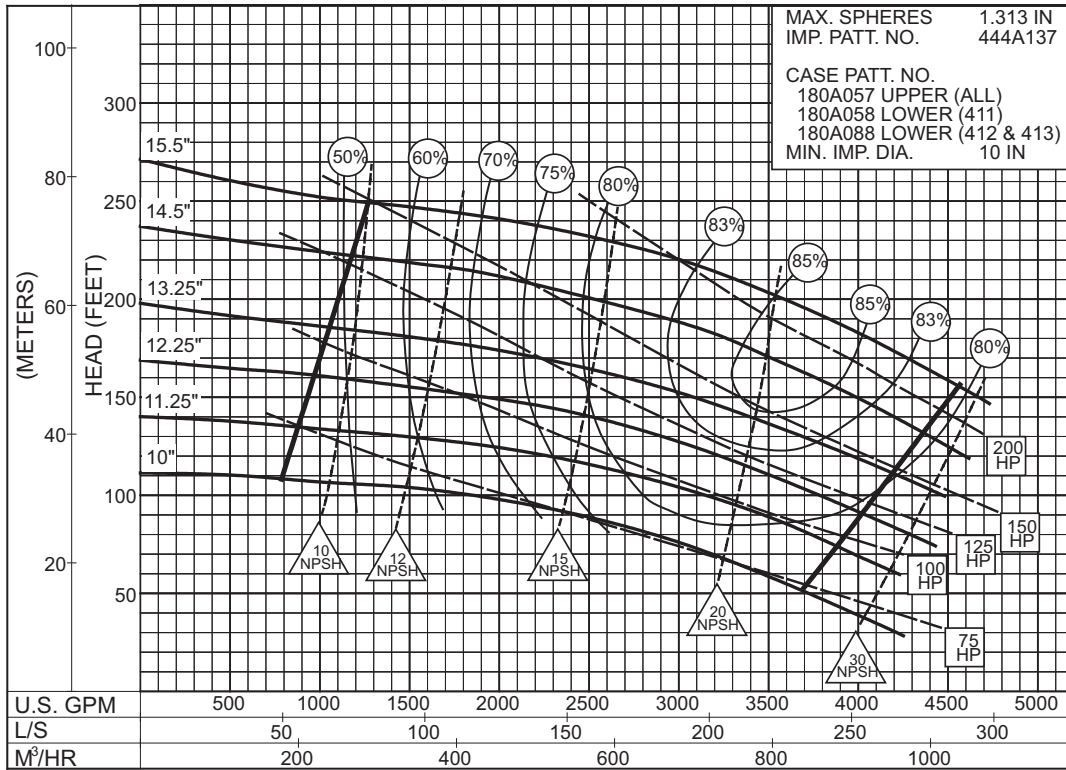

2PC-120356C

1775
RPM

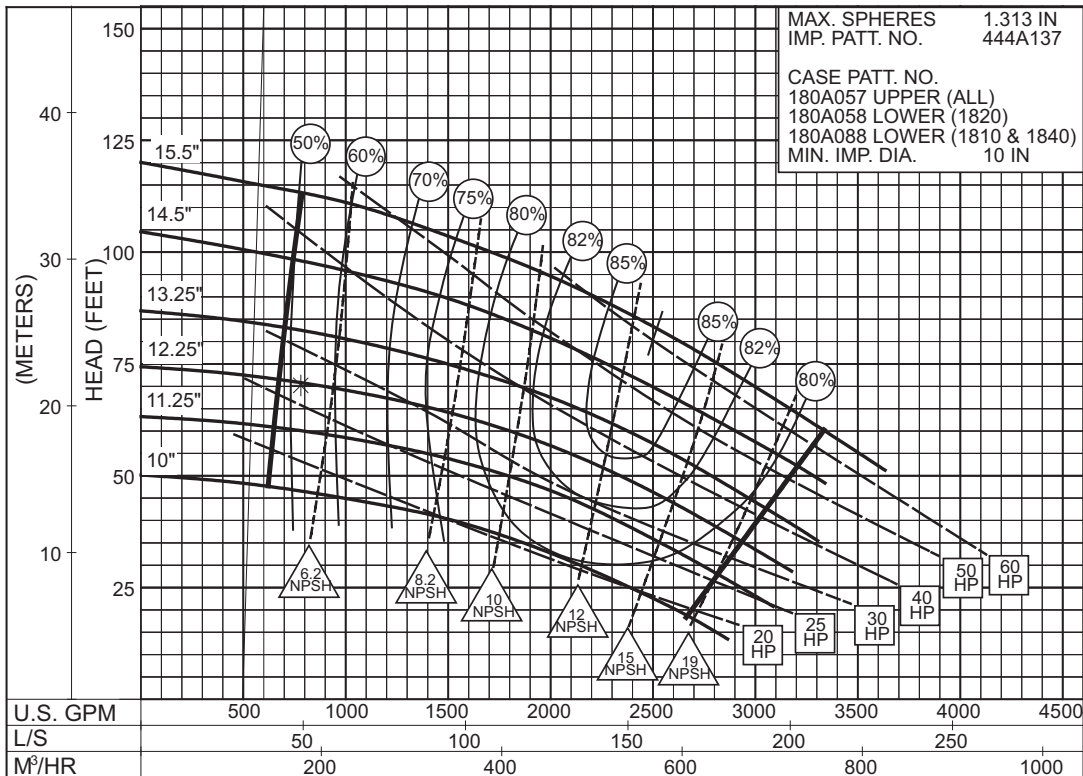

2PC-120357B

1180
RPM

8 x 10 x 17B SERIES 410

ENCLOSED IMPELLER

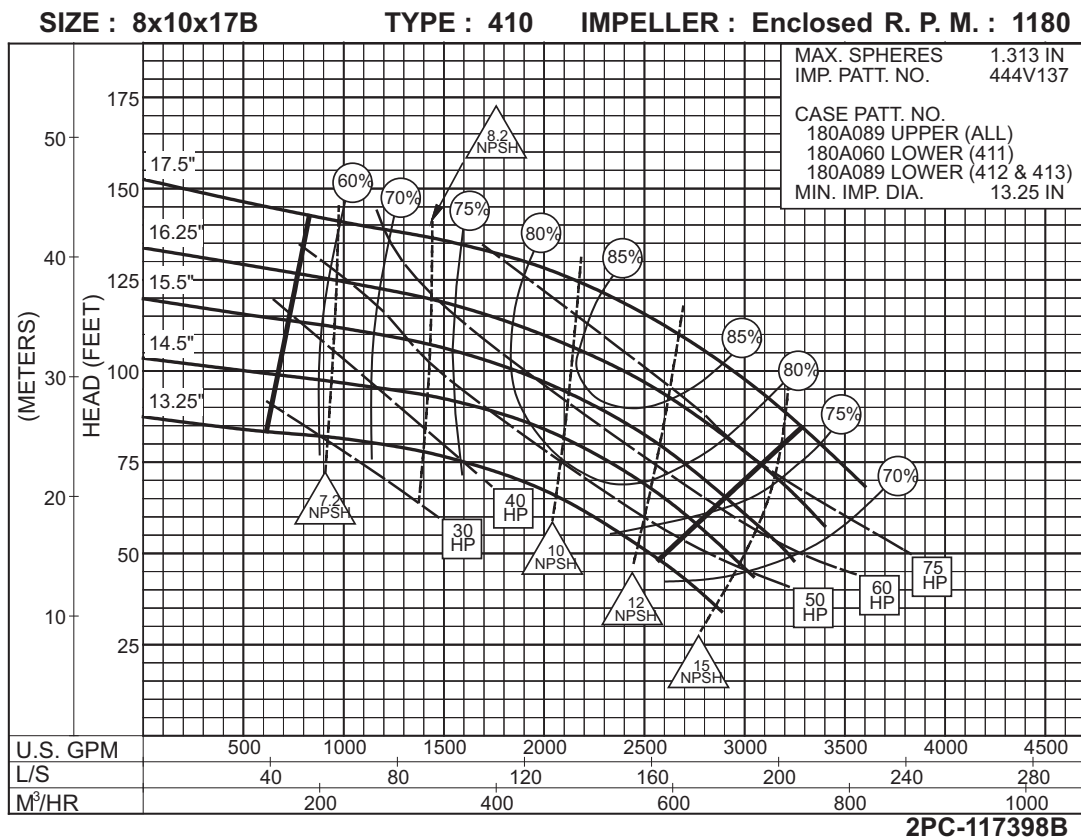
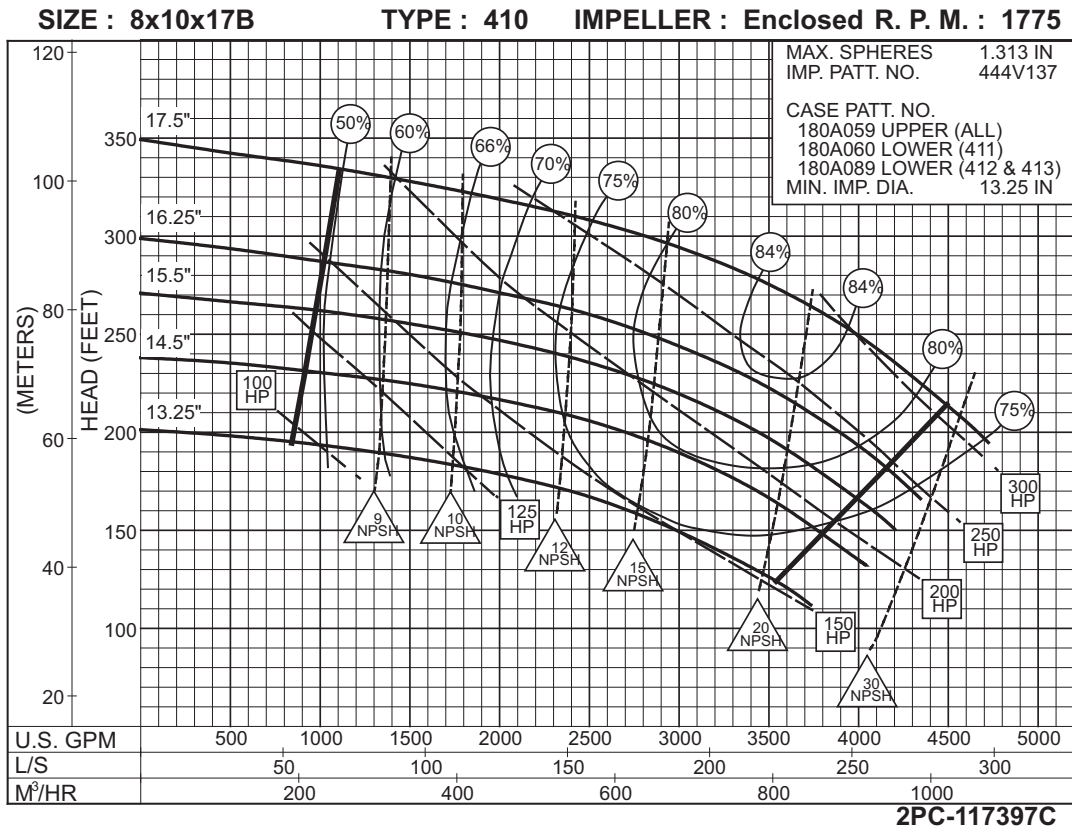

8 x 10 x 21
SERIES 410

ENCLOSED IMPELLER

SIZE : 8x10x21 TYPE : 410 IMPELLER : Enclosed R. P. M. : 1775

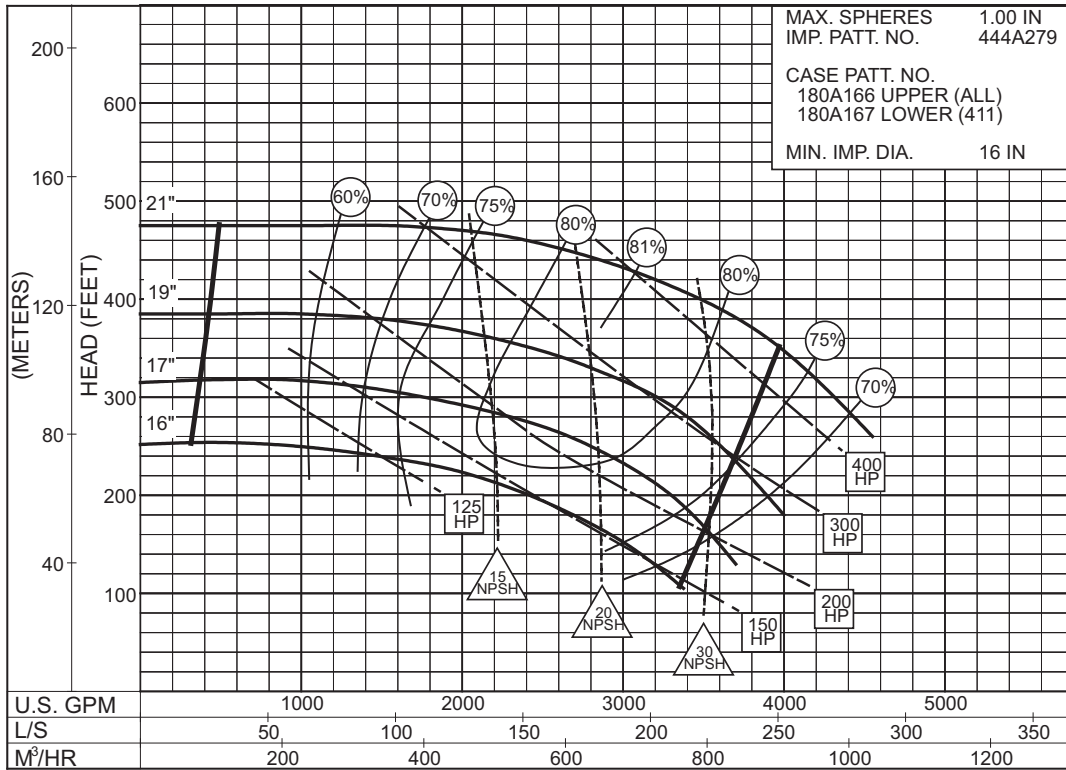

2PC-140831B

1775
RPM

SIZE : 8x10x21 TYPE : 410 IMPELLER : Enclosed R. P. M. : 1180

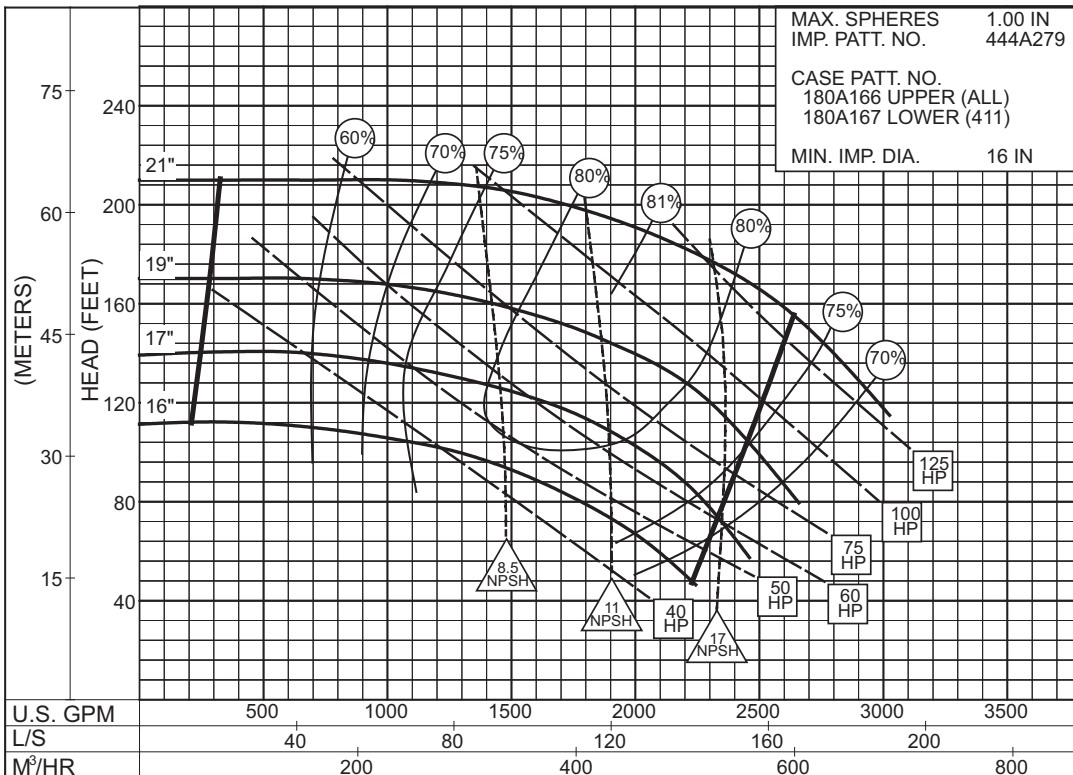

2PC-140832B

1180
RPM

8 x 10 x 21A SERIES 410

ENCLOSED IMPELLER

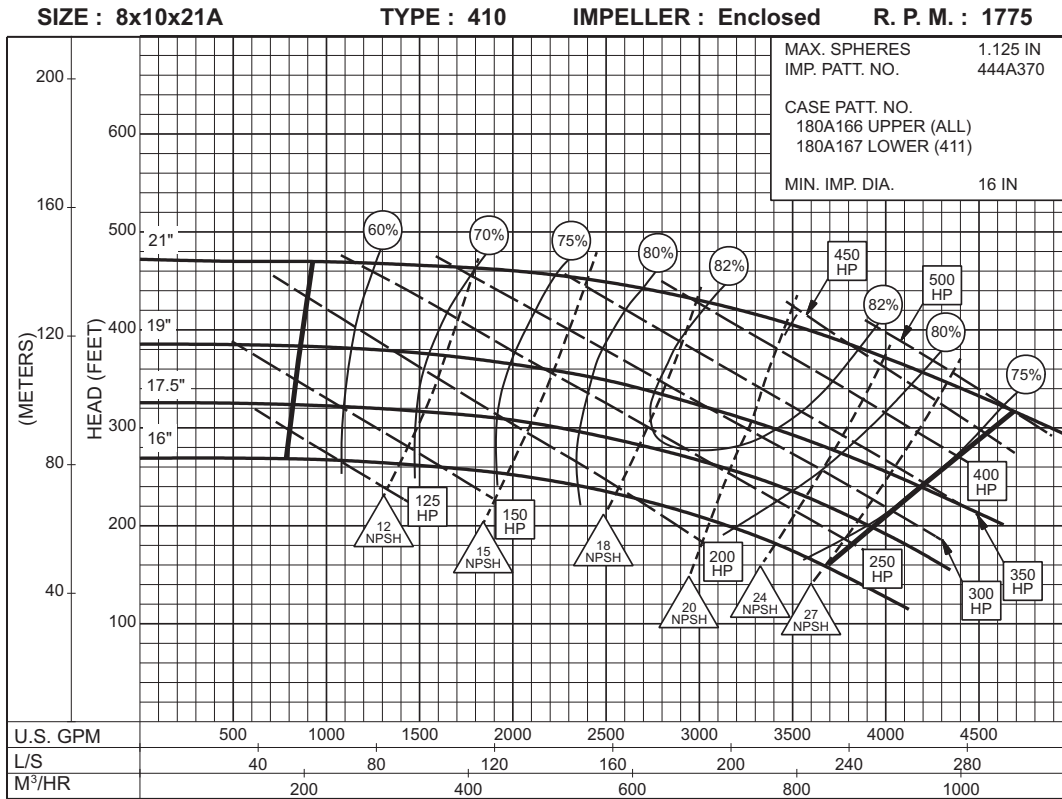

1775
RPM

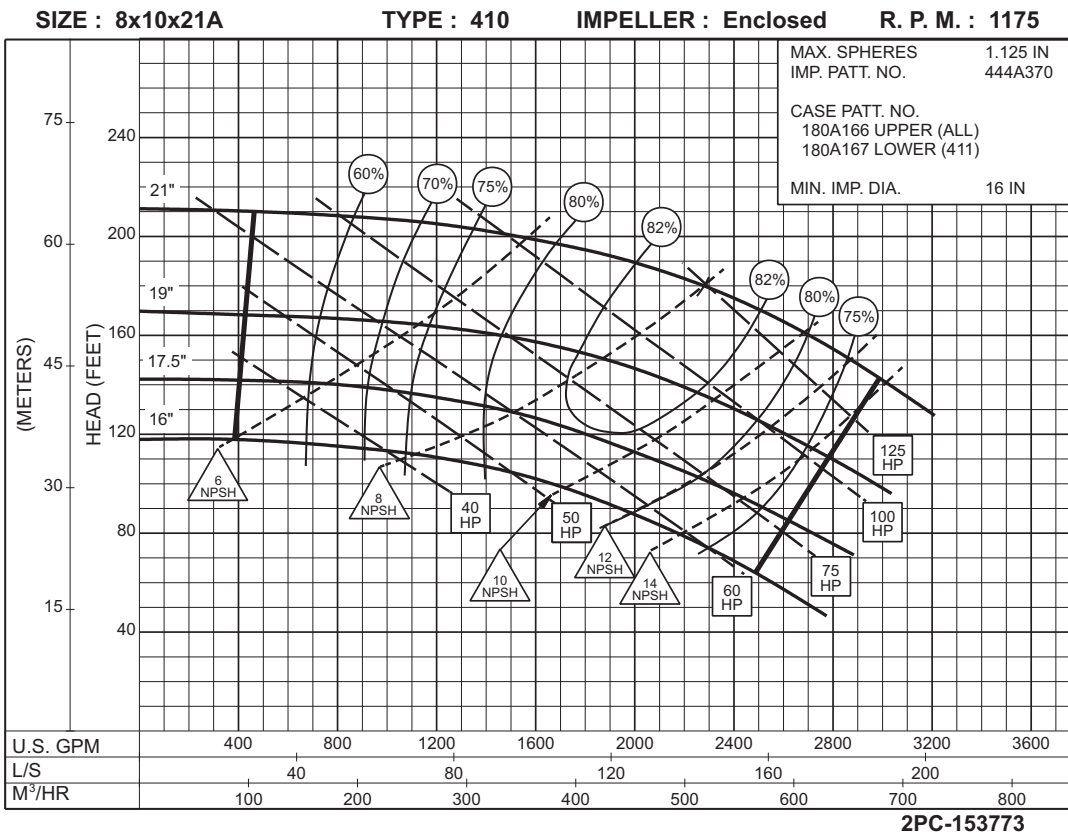

1175
RPM

8 x 12 x 24 SERIES 410

ENCLOSED IMPELLER

SIZE : 8x12x24 TYPE : 410 IMPELLER : Enclosed R. P. M. : 1770

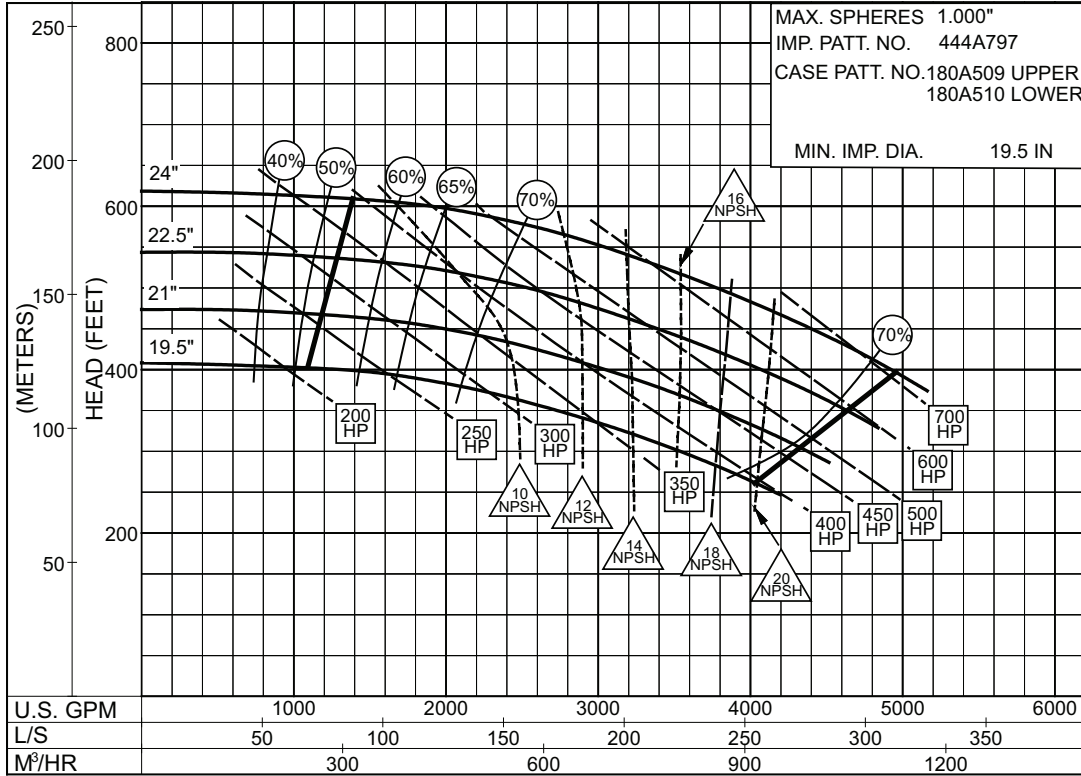

PC- 197423

10 x 12 x 12B SERIES 410

ENCLOSED IMPELLER

SIZE : 10x12x12B TYPE : 410 IMPELLER : Enclosed R. P. M. : 1775

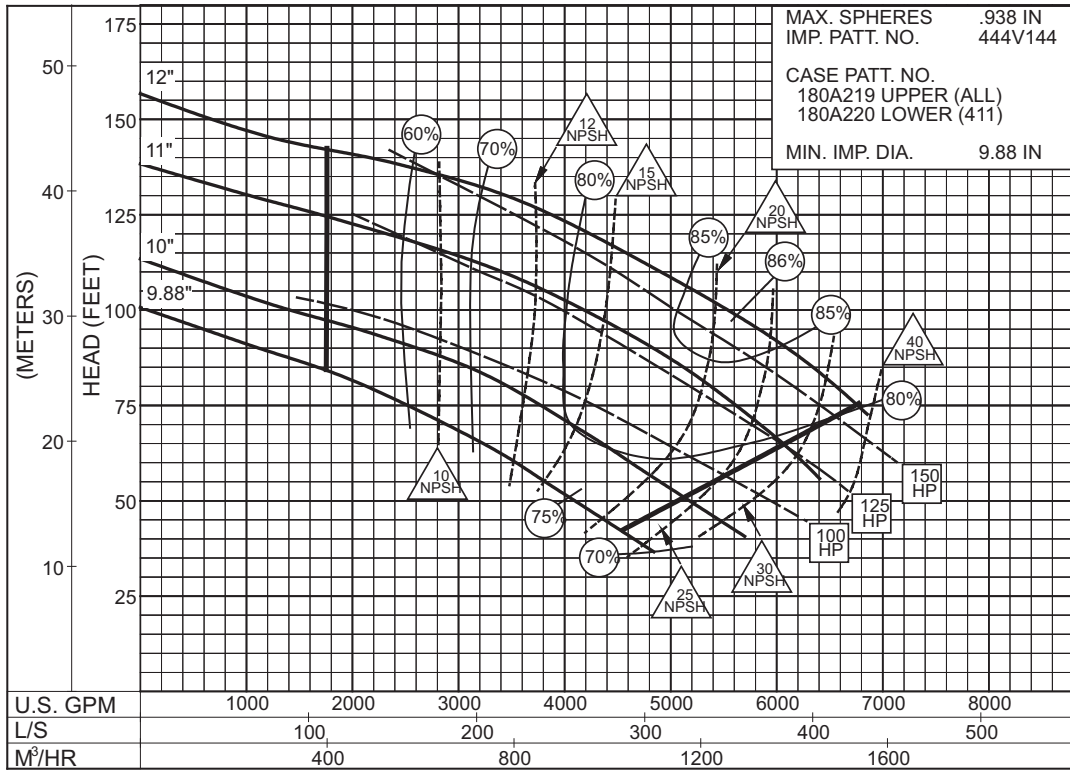

2PC-117399A

1775
RPM

SIZE : 10x12x12B TYPE : 410 IMPELLER : Enclosed R. P. M. : 1180

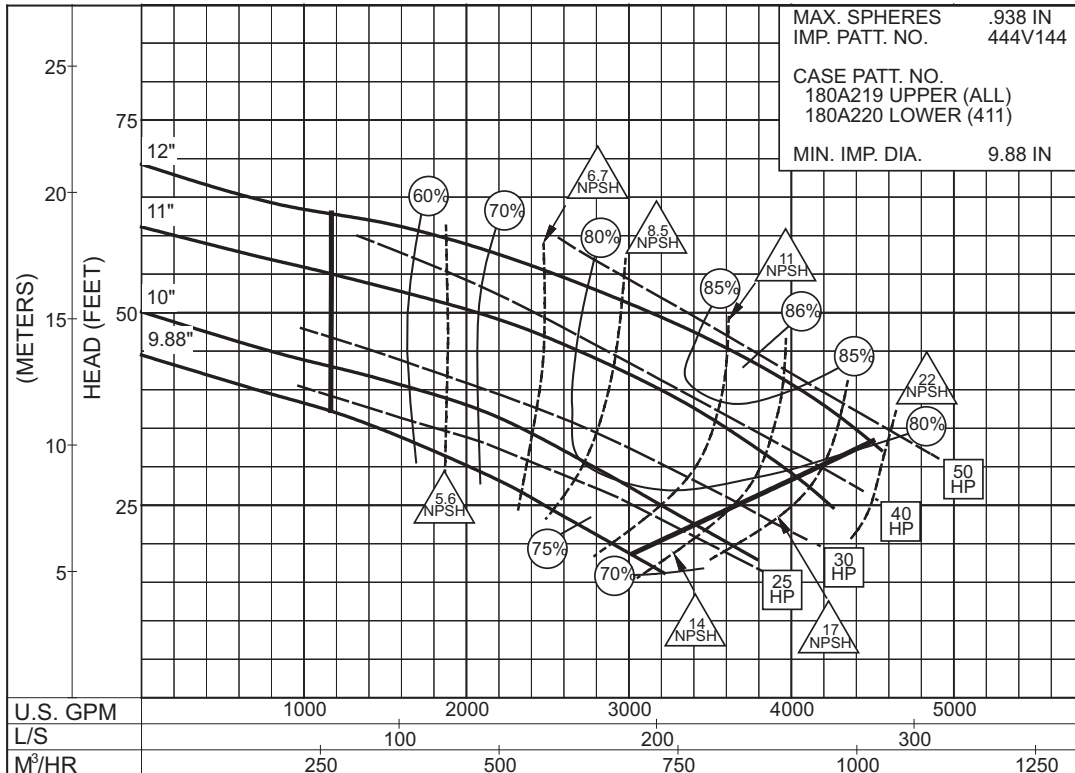

2PC-117400A

1180
RPM

10 x 12 x 15B
SERIES 410

ENCLOSED IMPELLER

SIZE : 10x12x15B TYPE : 410 IMPELLER : Enclosed R. P. M. : 1775

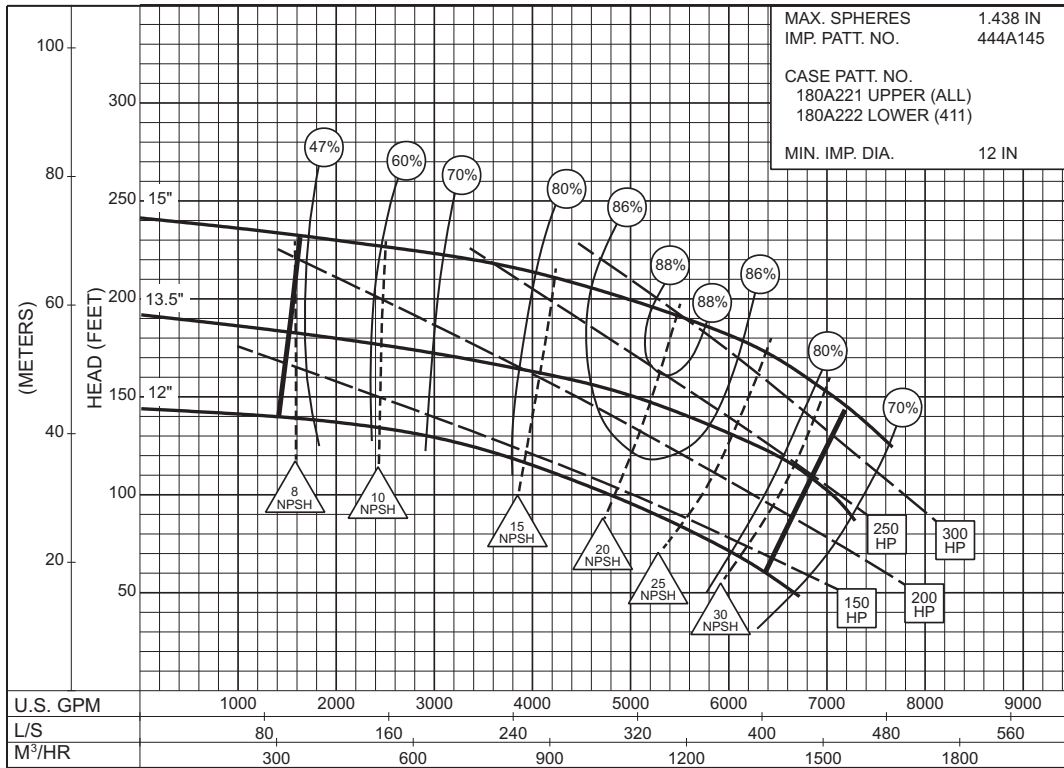

2PC-117401

1775
RPM

SIZE : 10x12x15B TYPE : 410 IMPELLER : Enclosed R. P. M. : 1180

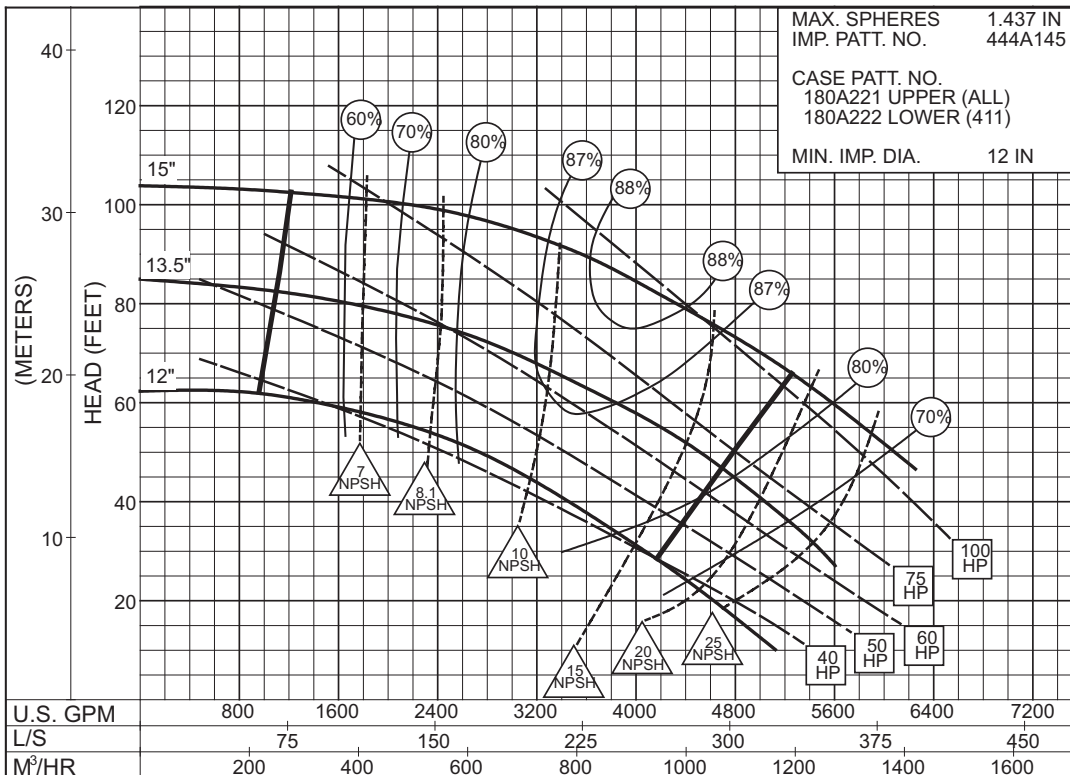

2PC-117402A

1180
RPM

10 x 12 x 15C SERIES 410

ENCLOSED IMPELLER

SIZE : 10x12x15C TYPE : 410 IMPELLER : Enclosed R. P. M. : 1775

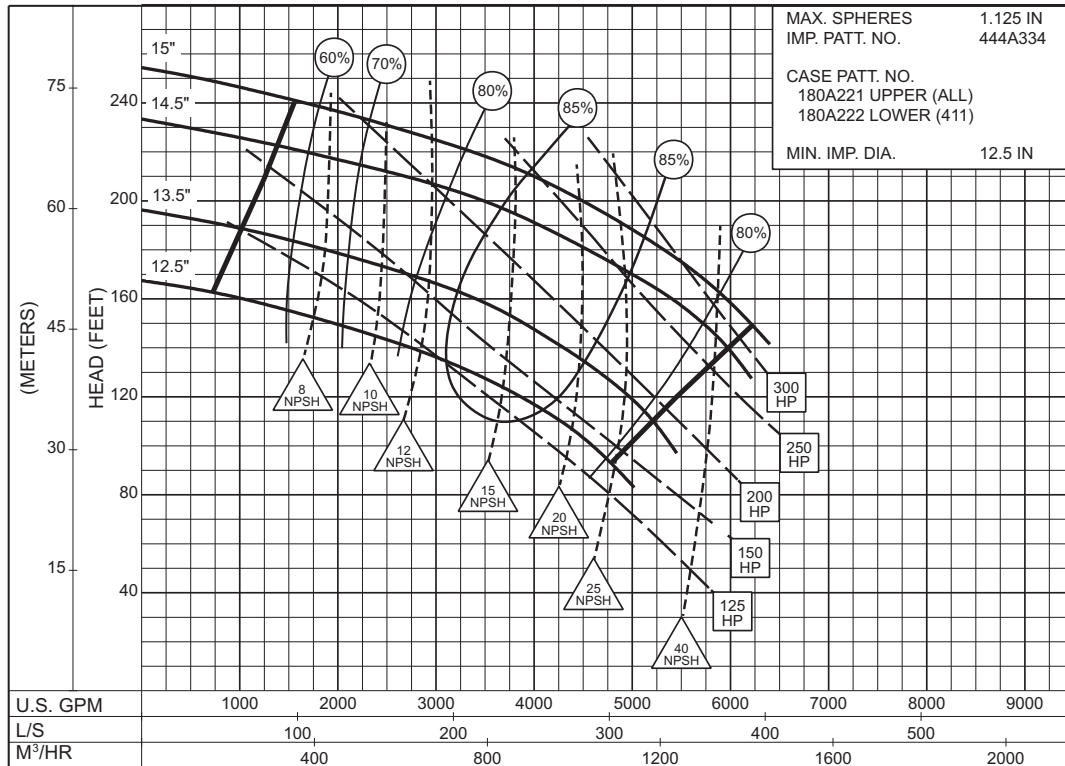

1775
RPM

2PC-125182

SIZE : 10x12x15C TYPE : 410 IMPELLER : Enclosed R. P. M. : 1180

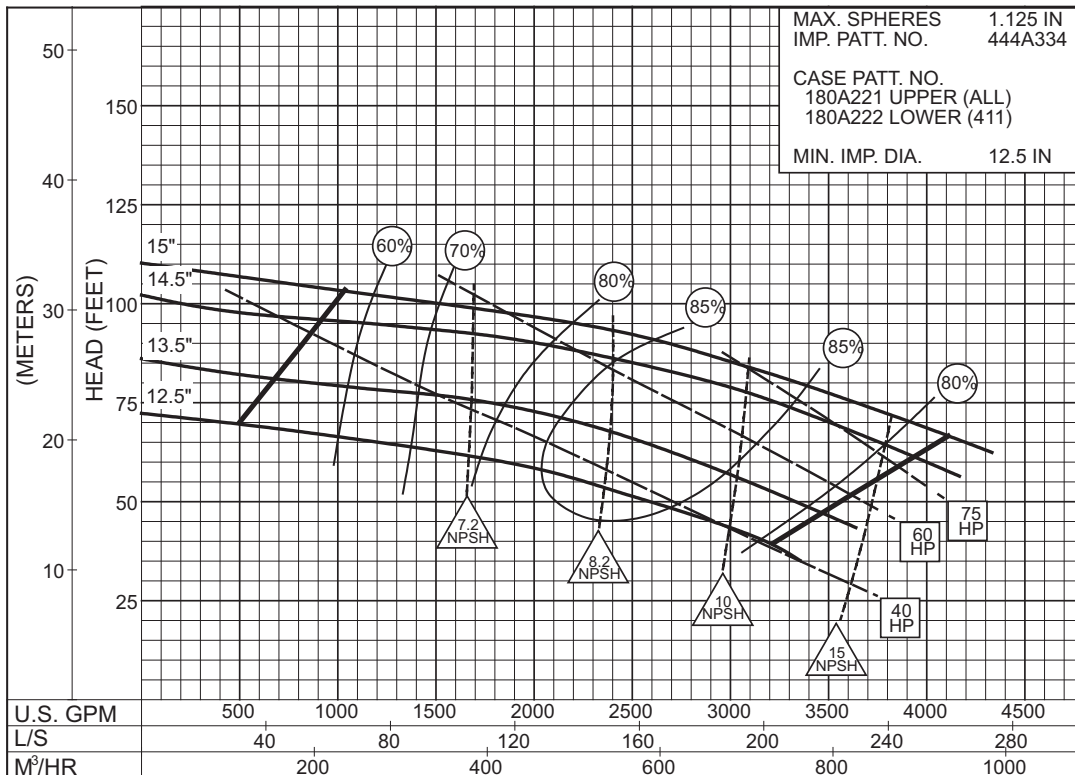

1180
RPM

2PC-125181A

10 x 12 x 18
SERIES 410

ENCLOSED IMPELLER

SIZE : 10x12x18 TYPE : 410 IMPELLER : Enclosed R. P. M. : 1775

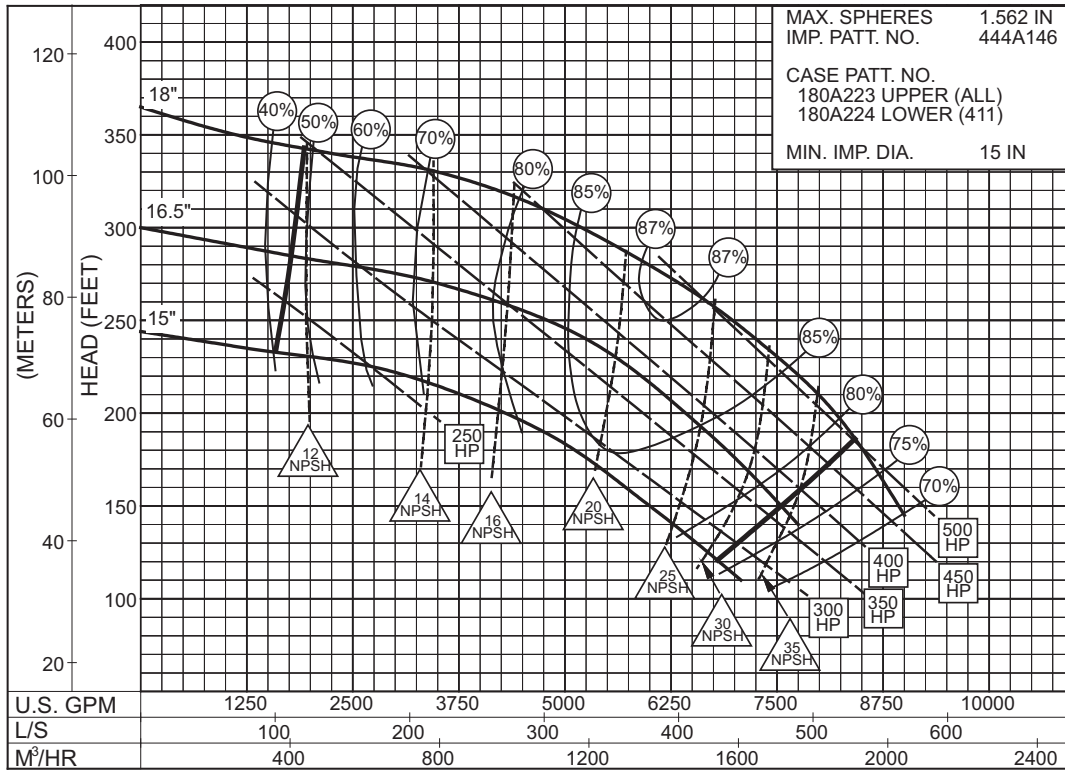

2PC-117403A

1775
RPM

SIZE : 10x12x18 TYPE : 410 IMPELLER : Enclosed R. P. M. : 1180

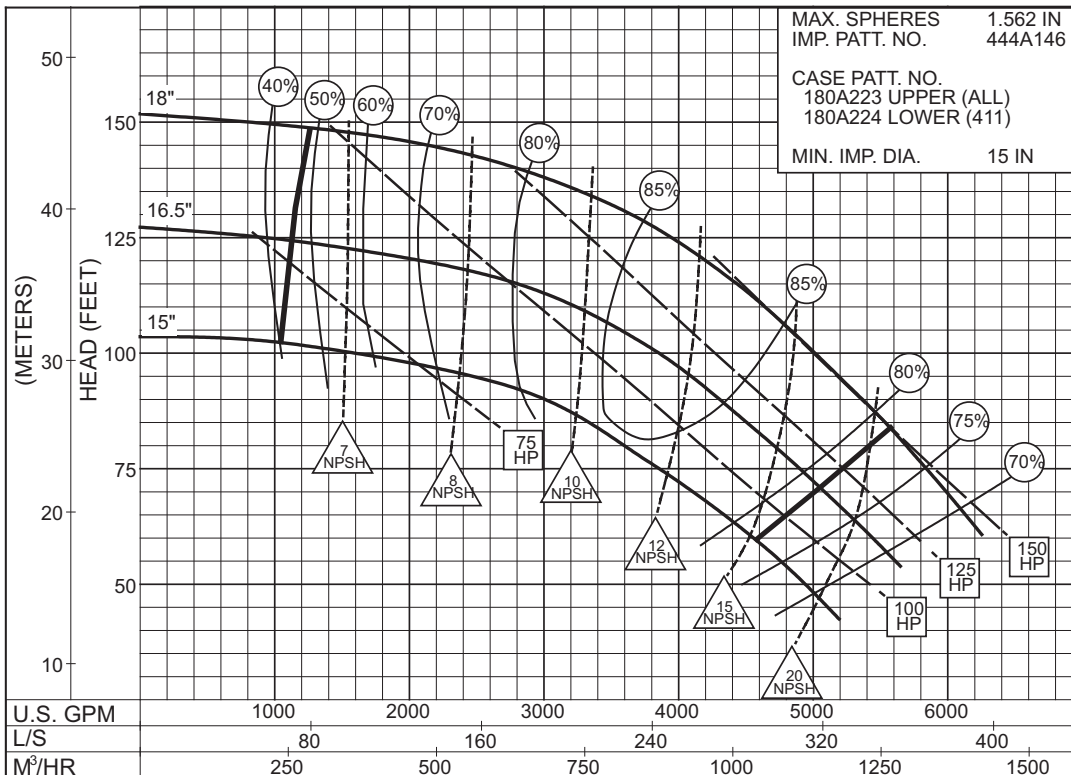

2PC-117404A

1180
RPM

10x12x18D SERIES 410

ENCLOSED IMPELLER

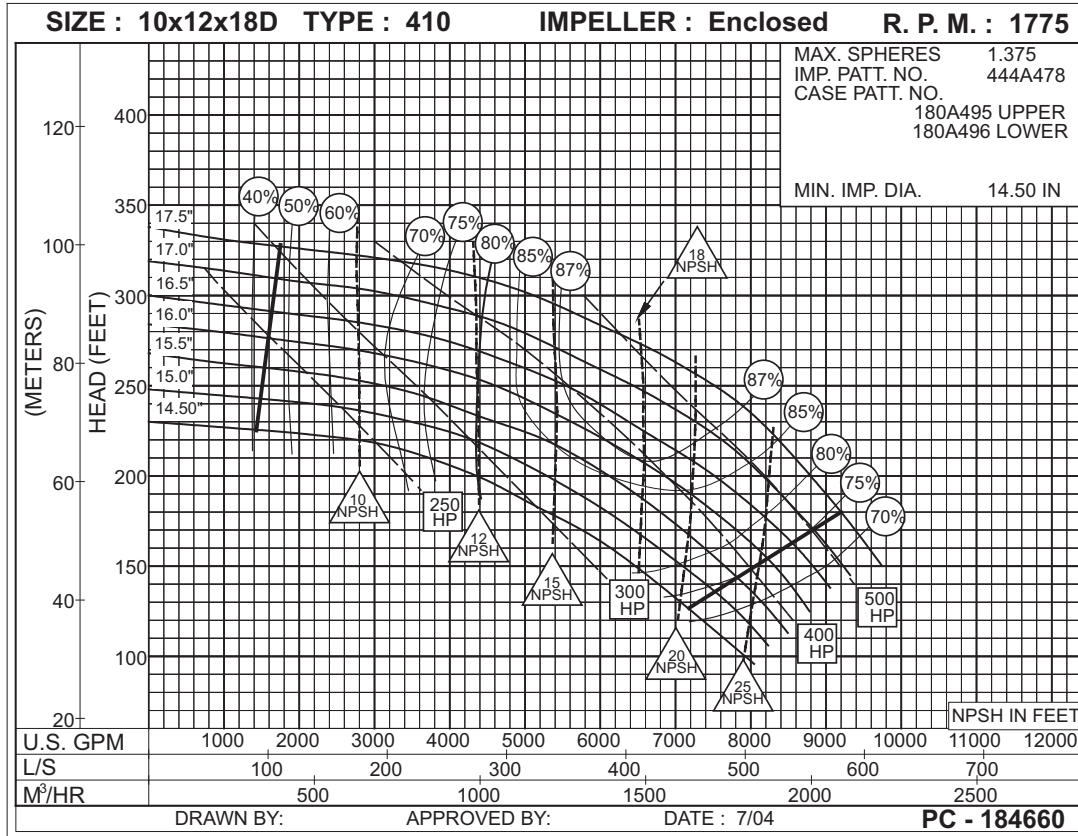

**1775
RPM**

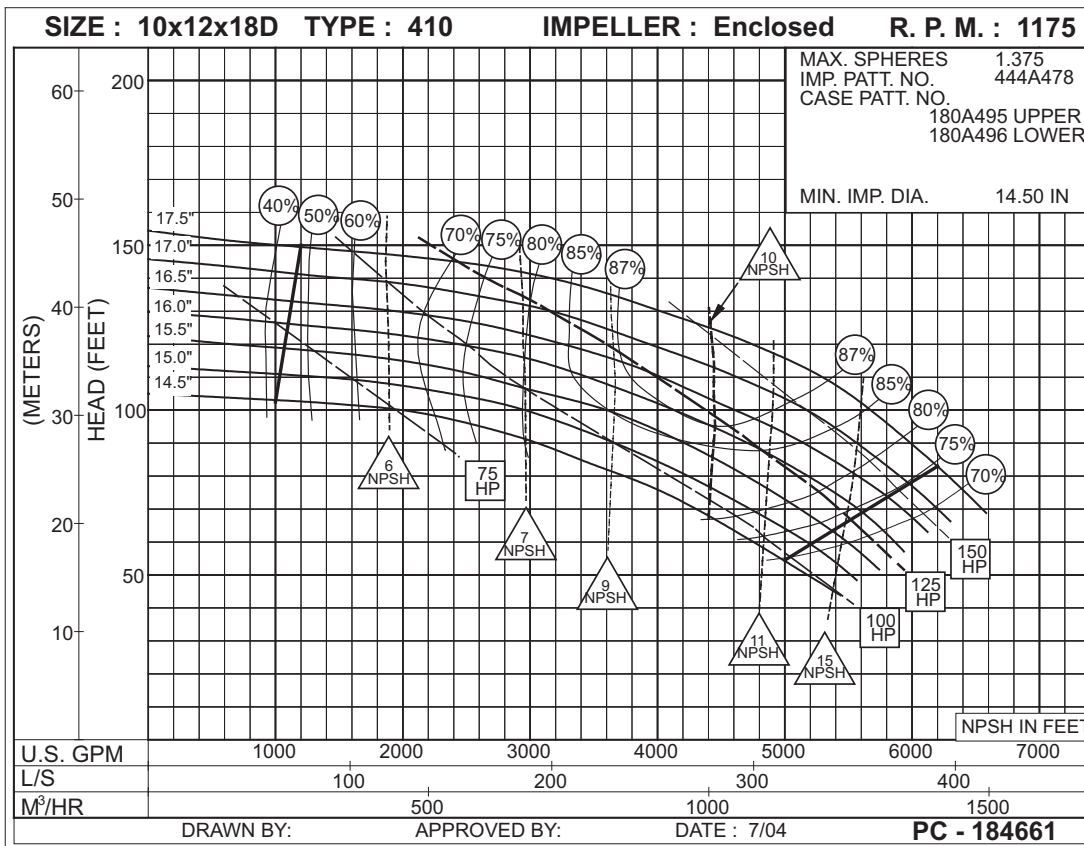

**1175
RPM**

12 x 14 x 15B SERIES 410

ENCLOSED IMPELLER

SIZE : 12x14x15B TYPE : 410 IMPELLER : Enclosed R. P. M. : 1775

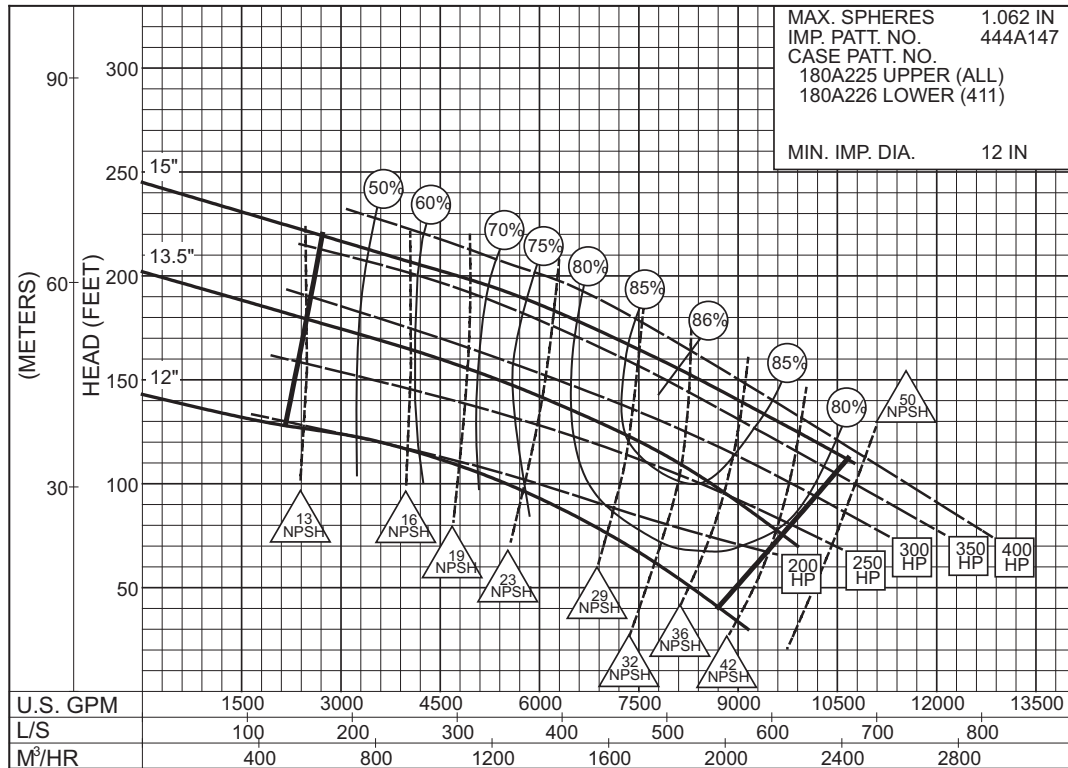

2PC-132822B

1775
RPM

SIZE : 12x14x15B TYPE : 410 IMPELLER : Enclosed R. P. M. : 1180

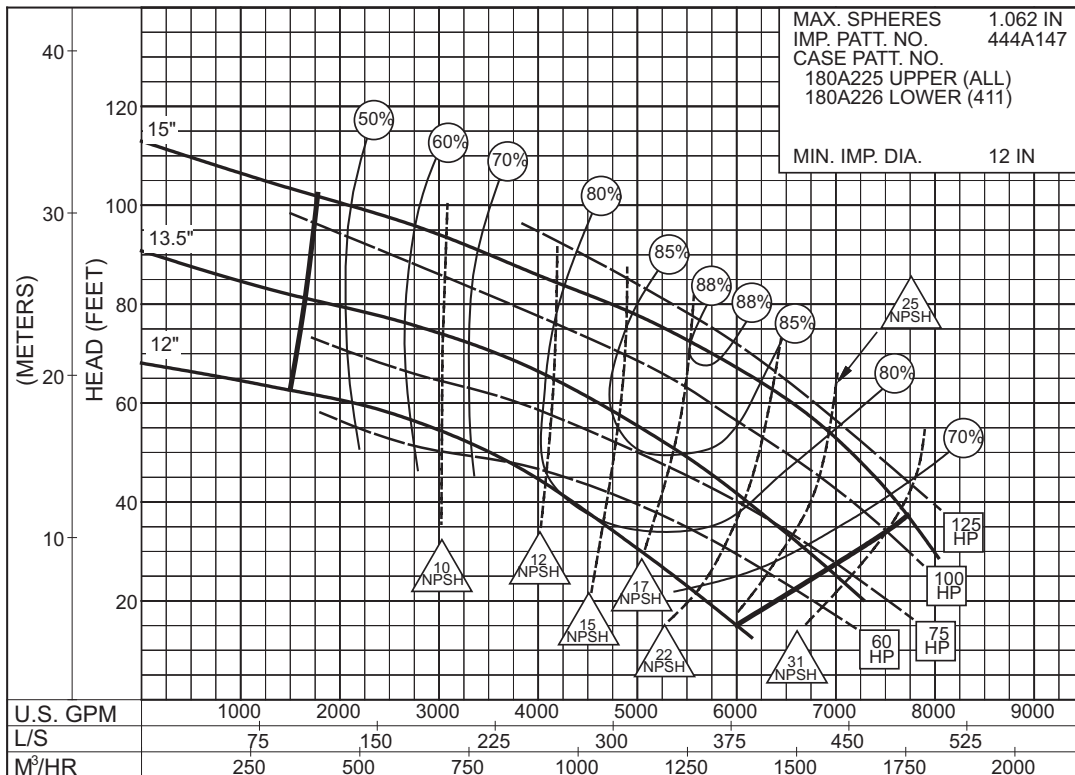

2PC-132823B

1180
RPM

12 x 14 x 18A
SERIES 410

ENCLOSED IMPELLER

SIZE : 12x14x18A TYPE : 410 IMPELLER : Enclosed R. P. M. : 1775

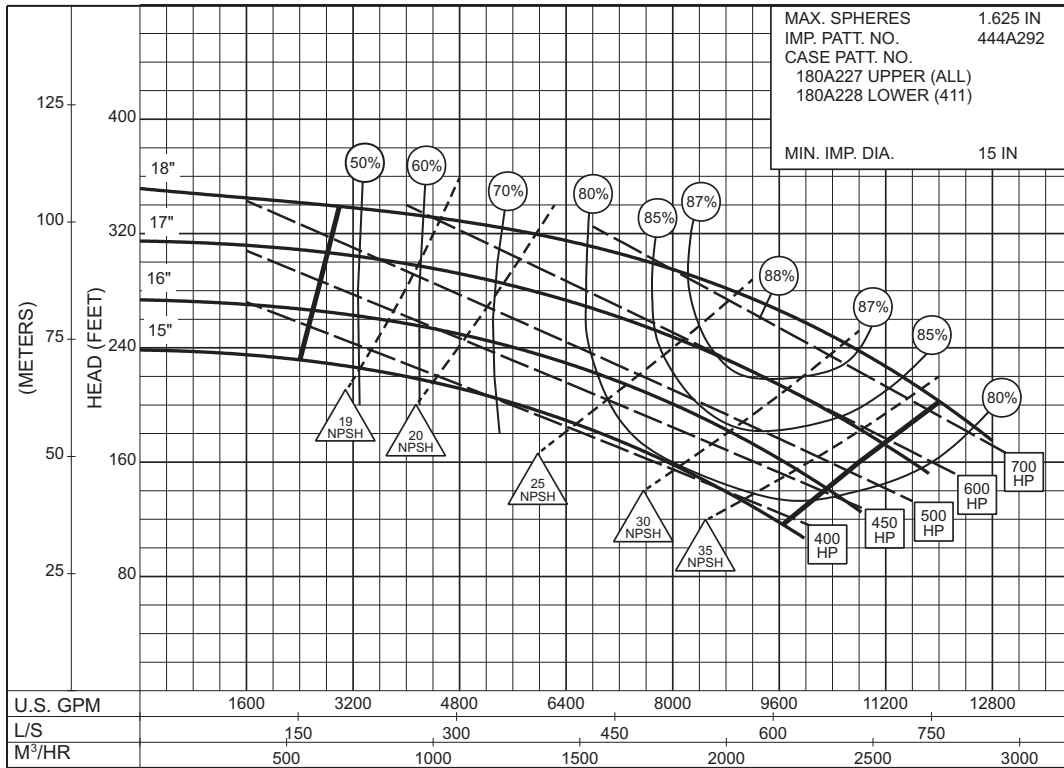

2PC-146258

1775
RPM

SIZE : 12x14x18A TYPE : 410 IMPELLER : Enclosed R. P. M. : 1175

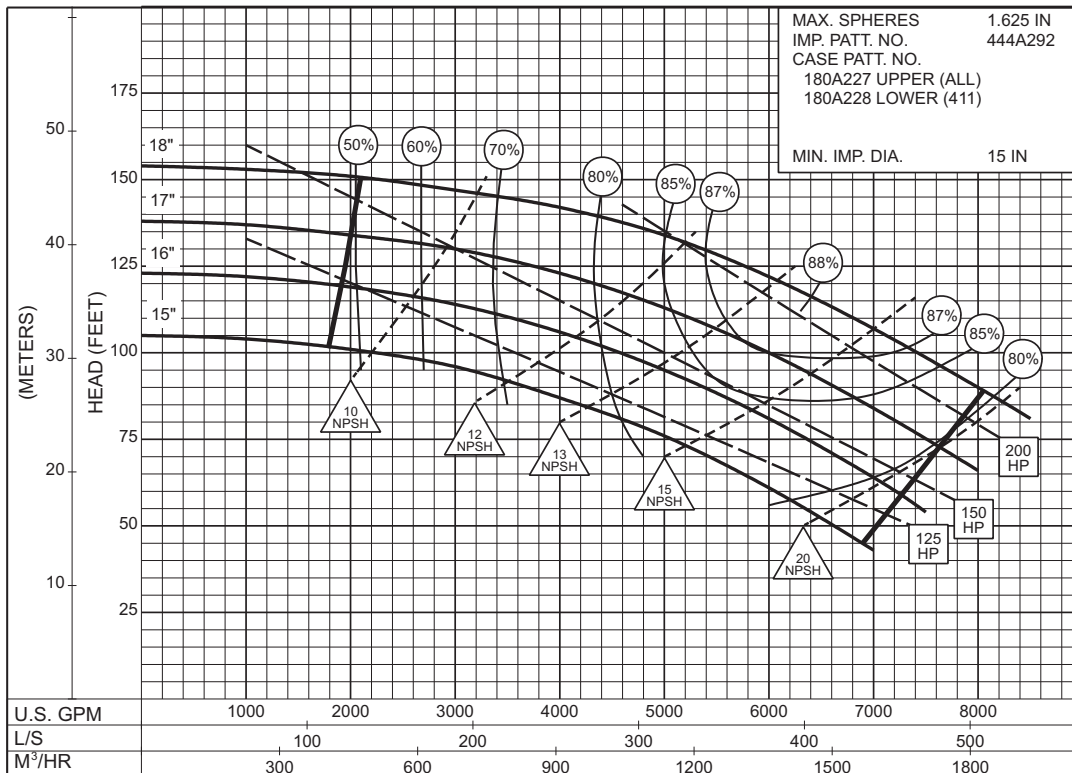

2PC-146257

1175
RPM

14 x 16 x 18 SERIES 410

ENCLOSED IMPELLER

SIZE : 14x16x18 TYPE : 410 IMPELLER : Enclosed R. P. M. : 1180

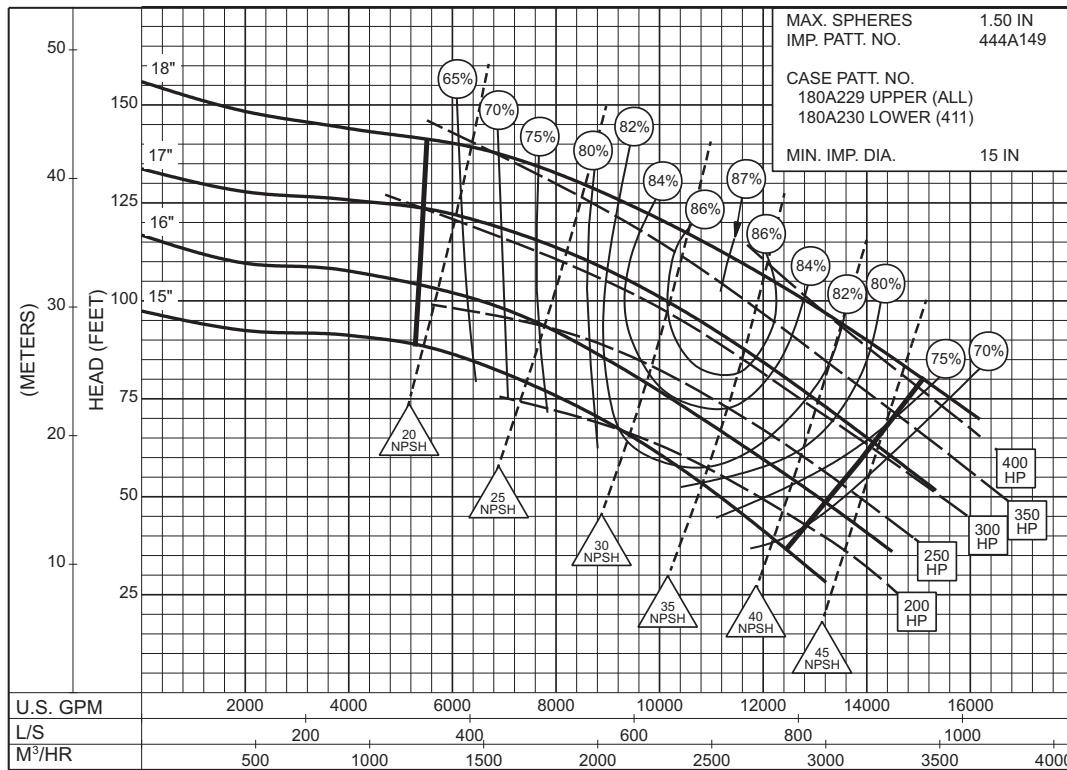

2PC-132250

1180
RPM

SIZE : 14x16x18 TYPE : 410 IMPELLER : Enclosed R. P. M. : 885

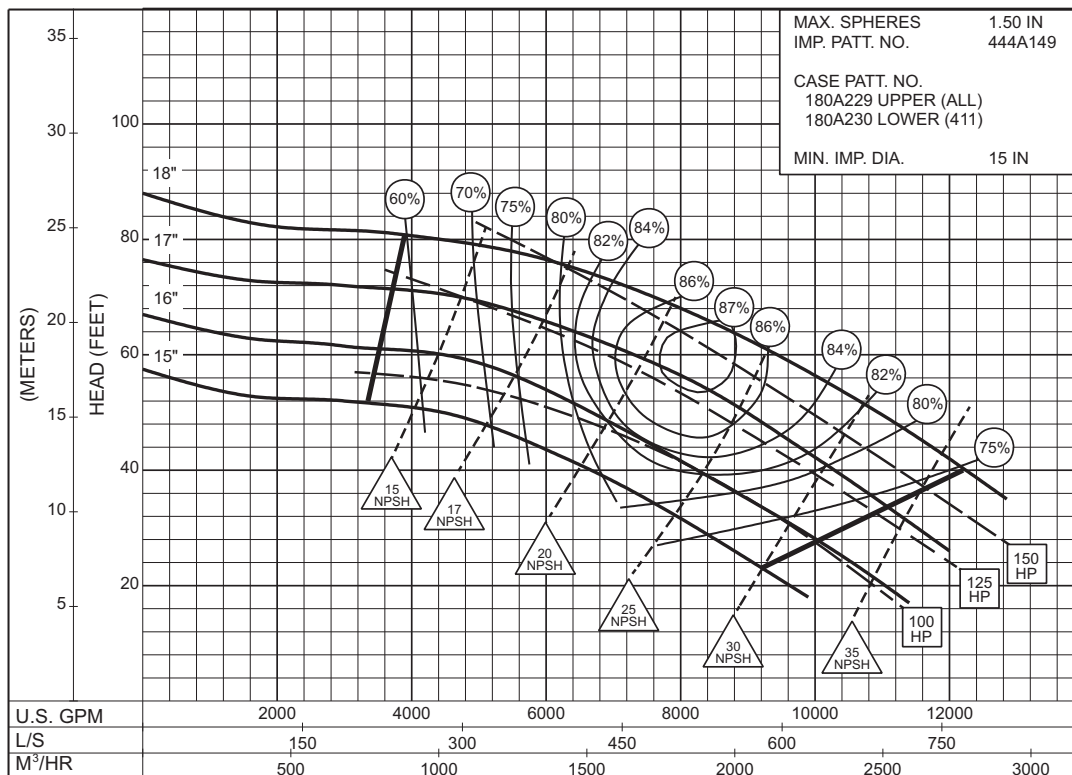

2PC-132251

885
RPM